

An adventure for use with
STAR TREK®
THE ROLE PLAYING GAME

THE OUTCASTS



THE OUTCASTS

An adventure for use with *Star Trek: The Role Playing Game*

Design And Writing: *Fantasimulations Associates*
Guy W. McLimore, Jr.

Editing: Wm. John Wheeler

Production:

Production Manager: Karen L. Vander Mey

Art Director: Dana Knutson

Cover Art: David Deitrick

Graphics, Layout, and Illustration:
Dana Knutson
Todd Marsh
Norman Millier

Typesetting: Karen Vander Mey

Proofreading: Donna Ippolito

STAR TREK is a trademark of Paramount Pictures Corporation.

STAR TREK III: The Search For Spock products are published by FASA Corporation under exclusive license from Paramount Pictures Corporation, the trademark owner.

STAR TREK: The Role Playing Game is published by FASA Corporation under exclusive license from Paramount Pictures Corporation, the trademark owner.

Copyright © 1985 Paramount Pictures Corporation
All Rights Reserved
Printed in the United States of America

No part of this book or the contents of the basic game may be reproduced in any form, or by any means without permission in writing from the publisher.

Published by FASA Corporation
P.O. Box 6930
Chicago, Illinois
60680-6930

Table of Contents

Introduction	3
Plot Synopsis	3
Description Of Contents	3
The Adventure	4
To Repay A Debt	4
An Unusual Message	4
A Second Message	5
Greetings From Sonam	5
The Vulcan Envoy	5
Decision Point	6
Mysterious Preparations	7
A Fortunate Invitation	7
The Vacation Estate	7
A Silent Alert	8
In Transit	8
The Departure	8
Enroute To Bonus Run	8
Briefing	9
The Plan	9
Arrival On Bonus Run	9
Greasing Palms	10
Hitting Dirt	10
Bonus Run Center Spaceport	10
Port Terminal Building	10
Random Encounters	11
The Visitors' Quarter	11
Loban Trade Advisors	11
Random Encounters	12
The Shadow Market	12
Player-Initiated Encounters	12
Random Encounters	13
The Pit	13
The Loban Warehouse	13
The Apothecary Shop	13
Random Encounters	14
The Financial Quarter	14
Delfi Corporation Offices	14
Random Encounters	15
The Residential Quarter	16
Suspicious Characters	16
Kaylo Delfi's Estate	16
Toora Delfi's Estate	16
Random Encounters	18
The Merchants' Quarter	18
The High Market	18
Delfi Small Lot Brokerage	19
Delfi Small Lot Warehouse	19
Random Encounters	19
Trap!	19
Ambush!	19
A Sip Of Brandy	19
Springing The Trap	20
Taking Prisoners	20
Interrogation	20
Eliminating The Evidence	30

An Air Of Murder	30
Two Guards On Watch	30
One Guard On Watch	30
No Outside Guards	30
Sniper Fire	30
Lift-Off	31
The Cavalry To The Rescue	31
Family Rivalry	31
Brawling In The Street	31
Meeting Toora Delfi At Last	31
A Trip To The Warehouse	32
Conference Time	32
Preparing A Proposition	33
Outcast Redeemed	33
The Conference Room Floor	34
Confrontation With T'Lovus	34
The Final Conflict	35
The Story Of T'Slak	35
The Vulcan Connection	36
T'Slak Dead	36
T'Slak Alive	36
Revisions To The Adventure	36
A Second Message From Sonam	36
Events On Bonus Run	37
Background Information	38
Bonus Run	38
Delfi Corporation	38
Kaylo Delfi	39
Toora Delfi	39
Bonus Run's High Market	39
Shadow Markets On Orion Tradeworlds	39
Cast Of Characters	40
Gamemaster's Notes	43
Hints On Play	43
Meeting With Salak	43
Purchasing Loban's Starship Sensors	43
Conferences In The <i>Terri Bear</i>	43
Bonus Run	44
Laws and Customs	44
The Shadow Market	44
Maps	44
Signpost Encounters	44
Bonus Run Spaceport	44
Visitors' Quarter	44
The Pit	45
Financial Quarter	46
Residential Quarter	46
Merchants' Quarter	47
Random Encounters	47
No Encounter	47
Pickpocket Attempt	47
Legitimate Street Dealer	48
Illegal Offer	48
Black Market Broker	48
Bureaucratic Hassle	48
Delfi Company Guards	48
Pull Out Section	21-28

Introduction

Gamemasters using this scenario should already be somewhat experienced with the **ST:RPG2** rules. They should also own or have access to **The Romulans**, which will give important background information on the members of that race. Players should be experienced in running the type of characters they have chosen (either Star Fleet officers or civilian adventurers), but they need not know any more about the Romulan Star Empire than the basic information in the Intelligence Sourcebook of **The Romulans**, much of which would also be easily available to civilians.

The adventure can be worked into any existing campaign, or run as a one-shot adventure not part of a larger campaign. Though the text was written from the point of view of Star Fleet Officers as player characters, players may use civilian adventurer characters with only slight modifications.

PLOT SYNOPSIS

One player character is contacted secretly by Sonam, an old Vulcan shipmate, who asks him to contact and cooperate with a Vulcan envoy on a secret mission, as described in **To Repay a Debt**. The Vulcan envoy is Salak, who wants the player characters' aid in his search for a Romulan outcast, or *k'manatram*, known to be operating on a nearby Orion-controlled tradeworld. Salak claims that he intends to help the Federation recruit the outcast Romulan as an agent. **Mysterious Preparations** details Salak's efforts to get ready for the mission.

In **In Transit**, the player characters accompany Salak to the tradeworld Bonus Run. During this journey, Salak gives them a briefing about the outcast and about the plan he has for making contact.

Once on Bonus Run, after they hit dirt as described in **Arrival At Bonus Run**, the player characters make contacts, hoping to get a line on the activities and whereabouts of the one they seek. Their questioning reveals that the renegade Romulan may be trying to carve a niche for himself in the tradeworld power structure. Interviews with a black marketer and a drug dealer provide clues. All of their encounters are described in the sections **Bonus Run Center Spaceport**, **The Visitor's Quarter**, **The Shadow Market**, **The Pit**, **The Financial Quarter**, and **The Residential Quarter**. Details on both planned encounters and random encounters are given in these sections.

The consequences of being detected at their work is given in the section **Trap!**, in which their quarry lays an ambush for the player characters. The events of **An Air Of Murder** also causes the stewing plot to bubble, and provides the player characters additional reasons for finding the outcast. The oven gets hotter if the player characters investigate dissension within the Delfi Corporation, as clues point to the highest levels of the tradeworld's governing corporation. This dissension is described in **Family Rivalry**.

The characters must penetrate the corporation offices to get a chance to approach the Romulan outcast. When they do, it is revealed that the corrupt Orion corporate president has been reduced to a drug-controlled figurehead, with the Romulan outcast once known as T'Lovus actually in control of the tradeworld. He is manipulating trade in this area with

the ultimate goal of causing an economic depression, leading to war that will involve all the powers in this area, including the Klingons, the Romulan Star Empire, and the UFP. T'Lovus believes his people have become too weak and need a war to weed out those not fit to be Romulans. He expects to regain his honor by precipitating such a war.

But the ambitions of T'Lovus are ended when he is attacked by Salak, actually a Romulan outcast once known as T'Slak. Cast out years ago for abandoning a mission that would have ended in war between the Romulans and the UFP, he has gained a chance to redeem himself, ironically, by preventing such a war. Unready for conflict with the UFP, the Star Empire used contacts with Vulcans such as the player characters' friend Sonak to find the only one who could identify T'Lovus without loss of honor – his former commander and fellow outcast T'Slak.

Depending on the player characters' actions, T'Slak is perhaps killed in an attempt (successful or not) to assassinate his old enemy T'Lovus, or later slain by an employee loyal to T'Lovus. Either way, his actions to stop the war redeem him. All these events are detailed in **Outcast Redeemed**. The secret cooperation of both the UFP and the Star Empire is revealed to the players in **The Vulcan Connection**.

DESCRIPTION OF CONTENTS

This booklet contains descriptions of all encounters in the adventure, character statistics for all major non-player characters, maps and data on the Orion-controlled tradeworld Bonus Run and the private office floor of the Delfi Corporation's building, and statistics for the player characters' *Mission Class II* small cargo vessel.

Also included are branching information on alternate directions for the adventure and notes for using the adventure with either Star Fleet or independent characters.

Permission is granted to photocopy character sheets, data files, maps, and floor plans for personal use in connection with running this adventure.

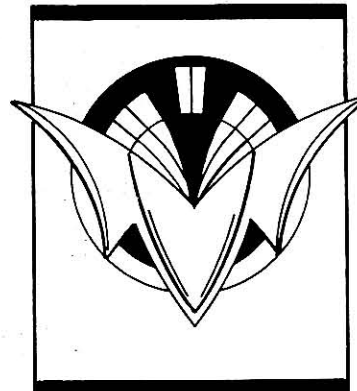

The Adventure

The text to lead gamemasters through this adventure will center on campaigns based around Star Fleet characters. Notes will be inserted where appropriate to change situations to fit civilian adventurers. This is particularly important during the opening sequence, in which players are introduced to the adventure situation. Read this section thoroughly and make whatever adjustments are necessary before presenting the information to the players.

In the sections that follow, information is given on the various encounters and encounter areas that occur in this adventure. Some of these descriptions will be used in a set order, as described in the sections. Others may not be used at all because of player actions. There is a separate section for the opening of the adventure, including the messages and encounters that set the player characters on the track. Another section provides the characters with essential background information and gives them access to more. Separate sections about the main areas the player characters will visit follow, as do sections dealing with the main antagonist. Gamemasters should read over and be familiar with ALL this material before playing.

TO REPAY A DEBT

AN UNUSUAL MESSAGE

The player characters' ship is in port at Levitt's World, a small Federation freeport near the UFP borders with the Triangle. Levitt's World is a friendly little place, having outgrown its origins as a free-wheeling frontier outpost and settled nicely into service as a stopover for UFP trade with Orion-controlled freeports nearby.

The adventure opens when the player characters, enjoying shore leave in a starport bar between assignments, are stopped by an official courier of the local planetary government. The courier has a sealed message tape addressed to the highest-ranking player character. Relaying that he was assigned to deliver the tape by the planet's communications chief, the messenger will ask for positive identification and then depart after the tape has been delivered.

The tape, of a type recorded by computer, is tamper-proof, insuring that no one – not even the local communications office – could have read its contents. The message can be played at any local computer terminal that can positively identify the user by ID card or retina scan, including any shipboard terminal or commercial phone terminal.

When he plays the tape, the highest-ranking character (known henceforth as the lead character) will find that it is neither video nor voice, but printed text from an old friend named Sonam, with whom he has many years of shared adventures. If the lead character is or has been a Star Fleet officer, then Sonam will have been his shipmate at some previous time; if the lead character is a trader who never served in Star Fleet, the character knows Sonam from when the Vulcan was stationed at a spaceport where the trader was making his headquarters at that time.

The lead character will feel that he owes Sonam a great deal of personal loyalty. Not long before Sonam was assigned to a position elsewhere, Sonam saved the character's life. (The gamemaster is invited to further develop this story, making it fit in with the character's background). Soon after, Sonam's work in the sciences was recognized by both the

Vulcan Science Council and the Star Fleet division of Scientific Research. He was decorated and promoted, and has since become very prominent.

The message reads as follows:

Greetings (character's first name goes here), old comrade!

I trust that this message finds you well and that your career is going smoothly. It has been a long time since we were in contact, but, as you know all too well, space is vast and distances are long. Sometimes, trying to maintain relationships while serving in Star Fleet tests even Vulcan patience.

I have been pursuing my duties here at Starbase 7 for several months, and I find my work as Sector Chief Of Scientific Operations challenging and rewarding.

I am still not used to being addressed as Commodore. Though I am out of the usual chain of command, I find it strangely unsettling to be suddenly senior to many of the officers with whom I served in the past. Some of my fellow Vulcan officers warned me that my Human comrades might react to my promotion with resentment, but this does not seem to be the case. I have been around Humans long enough to recognize such emotions, though I do not pretend to understand them. Most of my old companions have expressed pleasure at my elevation in rank, however. Of course, I know quite well how you felt about the matter. Your expression of feeling at the going-away party you threw for me when I was reassigned was quite unmistakable. The light-sculpture of my old ship that you gave me on that occasion adorns my desk even now (I have suppressed the extra circuit), and the memories of our talks together are very important to me.

It is difficult for me to presume upon an old comrade by asking for a favor, but circumstances require I do so. Much of what I ask herein I cannot explain, but I know I can trust you to help me at this time. Much depends on this, my comrade – more than either of us knows, I am sure.

You will be contacted sometime in the next two days by a Vulcan named Salak, who will identify himself by telling you the result of our final chess game. Salak is on a mission of utmost importance to the Federation, and one that must remain absolutely secret.

Choose a few of your best fellow officers and meet with Salak. When you have heard what he has to say, I urge you to aid him with his mission. I will pull whatever strings I must at this end to free you and those you choose to aid Salak in whatever way he desires. Such manipulations of schedule must be done quietly, and so I have avoided the usual Star Fleet channels in delivering this message. You must not discuss this communication, Salak's mission, or your part in this with anyone who is not to take part with you in the mission itself. You will have no official Star Fleet sanction, and so you must rely on those personally loyal to you. If I know you, there will be many such persons serving with you.

Do not attempt to contact me until the mission is completed. I cannot respond, and would be forced

to deny all if approached publicly. I know this is irregular, but the circumstances are irregular as well. I can only rely on a Human quality that I have admired but never understood — trust. (We Vulcans trust what we observe and can verify, but Humans trust in intangibles such as personal loyalty and friendship. Of course, these things cannot be part of my psychological makeup, but I have observed them and I count on them now.)

For whatever it is worth, I wish you the luck that you Humans seem to put so much faith in. If "luck" exists, may it favor you and this mission.

Sonam

The letter contains references that will cause the lead character to believe its author was Sonam, referring as it does to incidents that few but Sonam would know about, particularly the chess game and the extra circuit in the light sculpture. These should be pointed out to the lead character, by way of giving assurance.

For example, the character will remember that he/she managed to beat Sonam in that last game — something that had never happened before — and had done so in only 24 moves. The light-sculpture (a decorative desktop hologram that no one else but Sonam would know about) incorporated a special sound circuit that, whenever the device was activated for longer than an hour, played a piece of popular music Sonam particularly disliked. The lead character will believe that the circuit would be hidden until the sculpture was installed permanently on Sonam's desk at his new assignment, and also that Sonam would disable the circuit once it was found.

Checking with the planetary communications office will reveal that the message was sent from Starbase 7, under diplomatic seal. The character will find this highly unusual, in that Sonam would not normally have access to such authority. Even so, it is one of the few ways he could have sent a secure message to the character without using Star Fleet channels.

Any attempt to further confirm the message will be met by the exact sort of denials the letter told the character to expect.

A SECOND MESSAGE

Upon returning to his quarters, the lead character will find a message waiting for him. This message is a request from Salak that the lead character meet him as soon as possible at the local starport Hilton hotel. The characters will know that hotel is one of the better such establishments, catering mostly to well-to-do merchants, tourists, and traveling dignitaries.

Inquiries at the Hilton will reveal that a Vulcan by that name is indeed registered at the hotel. If Salak is called, he will answer with voice only, the viewscreen turned off. If the desk clerk is given the lead character's name, the clerk will state that the lead character is expected and should go directly up to Salak's room.

GREETINGS FROM SONAM

The first impressions about Salak and the mission he proposes will shape how the characters interact for the rest of the adventure. Care should be taken to role-play the character of Salak very carefully.

Either upon giving the door signal or upon placing a viewscreen call, a strong-yet-pleasant male voice will ask for identification. When the lead character identifies himself, Salak will either instruct him to enter or show himself on the viewscreen. In either case, he will be revealed as a tall, dark-haired figure wearing a typically-Vulcan formal, long-sleeved robe. He appears to be of between 50 and 80 years old, perhaps older. The lines in his face make it unlikely that he

is younger than that, and furthermore he carries himself with too regal a bearing to be younger.

"I am Salak," he will say. "I bring greetings from Sonam, who says to tell you that he has improved, and he believes that it may take more than 24 when next you meet. Why did you choose that music?"

If the lead character responds correctly, he will be invited in (or to Salak's room, if he had been called on the view screen).

THE VULCAN ENVOY

In Salak's hotel room, after introductions have been performed, Salak will gesture to a set of comfortable chairs and ask the characters to be seated. He will not seem surprised or upset if the lead character has brought friends, but he will comment that their discretion about the matter at hand is vital, and that he trusts the lead character will vouch for the silence of all his companions.

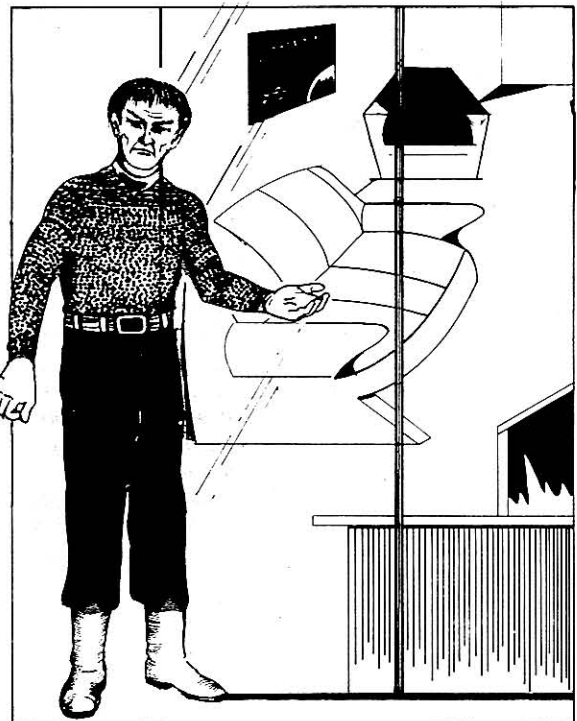

When all are seated, Salak will casually touch a glowing panel on a nearby end table. The room lights will soften to a comfortable, conversational level and a soft clicking noise will be heard.

"Forgive me," he will explain, "but I have sealed the door, and activated a field which will insure our privacy. No communications device or spying technique, no matter how sophisticated, can penetrate this room now. It is fortunate that this hotel has suites such as this one, for the privacy suits my purpose."

"The security of the entire Federation is at stake, but the Federation is powerless to act openly. I sought the help of Sonam on a matter of much urgency, and he has sent me to you."

Salak will proceed to brief the players on the mission he would have them undertake. During this briefing, he may reveal more of his real nature than he would wish; this is discussed in the **Gamemaster's Notes**. The gist of Salak's conversation follows, though this should be role-played, not merely read to players. The gamemaster must be particularly careful how he role-plays Salak, as discussed there, for it will color how the player characters view Salak and their mission.

"Perhaps some of you have heard the term *k'manatri* in your travels. The term is not unknown along the Neutral Zone and within areas like the Triangle where Romulans have been active. The word is Romulan and refers to those who have, for one reason or another, been cast out by their families and their culture for misdeeds or actions that indelibly stained their honor.

"A *k'manatram* may not be acknowledged by Romulan society, nor by any Romulan individual. He may not be aided, spoken to, or even noticed by anyone. He is barred from all contact with his own kind. Honor means much to Romulans, and most who lose their honor in this way kill themselves to avoid the shame. A minority try to force themselves on society or use their *unseen* status to cause trouble or harm. These often die accidentally."

The Vulcan hesitates, then continues. "A very small number, however, find a way to leave Romulan space, some come to lawless areas like the Triangle or the Orion worlds. They are the worst sort of cutthroats and pirates, for the most part. Most of these were not important to the Romulan Way before their casting out."

"Until this one," Salak says as he touches another glowing control on the table at his side. The air shimmers above the table and an image of a small ship appears.

"Over a year ago, this ship, stolen from a military installation, left a Romulan colony world. It was traced to the Orion-owned tradeworld known in Human space as "Bonus Run." There part of it turned up in the stock of an underworld dealer in shipboard systems. Obviously, the ship was dismantled and sold it after its arrival.

"It is believed — and this belief has been confirmed by methods I cannot discuss — that the thief is a *k'manatram*. The Federation needs the knowledge he possesses, and it is my task, which I hope you will make yours, to find him and recruit him as a Federation agent. Approaching this individual will not be easy, even if he can be found.

"This individual's name and likeness are, of course, not known, though it is certain that he is male and in the fourth decade of his life. All records of such are destroyed when someone is cast out, and no Romulan would even admit such a person existed, let alone identify him. Even so, he is known to be a person who was once of political importance, and is known to be active on Bonus Run. He has been on Bonus Run no longer than 15 months and no shorter than twelve. He is a skilled pilot, navigator, and combat soldier, but I think it unlikely that he will attempt to pursue these professions directly. It would be too risky to do so. He will more likely try to find other work that suits these talents.

"I need help to find this individual. Bonus Run is not a large place, and a Vulcan alone there would be somewhat conspicuous. It would be your job, if you are willing, to be by my eyes and ears; my knowledge would guide you. It will be dangerous, as he will surely be suspicious and wary. It will be necessary, I am sure, to lure this individual out and trap him before our proposal can be put to him."

The player characters will, of course, have many questions about the mission, but Salak will turn most of them aside, stating that he cannot answer for *security reasons* unless they decide to aid him. He will not even tell the characters what service he, Salak, works for, nor why he was chosen for this task. If asked how he knows so much about the Romulans, he will say, "I have spent my life studying Romulans. It is, in a way, my profession."

DECISION POINT

Salak will ask for the player characters' decision immediately, for departure to Bonus Run must be within the next 24 hours, on the transportation he has arranged. He will allow the player characters privacy to discuss the matter, if

they desire. If the lead character is alone and wishes to consult with friends, Salak will reluctantly allow the lead character one hour to contact them and bring them back to the suite before giving him an answer.

Salak will tell any Star Fleet characters who inquire that he can make arrangements to have them detached from duty for this mission, without revealing the nature of the mission to their shipboard comrades or to normal Star Fleet channels. Their involvement will be secret and unofficial.

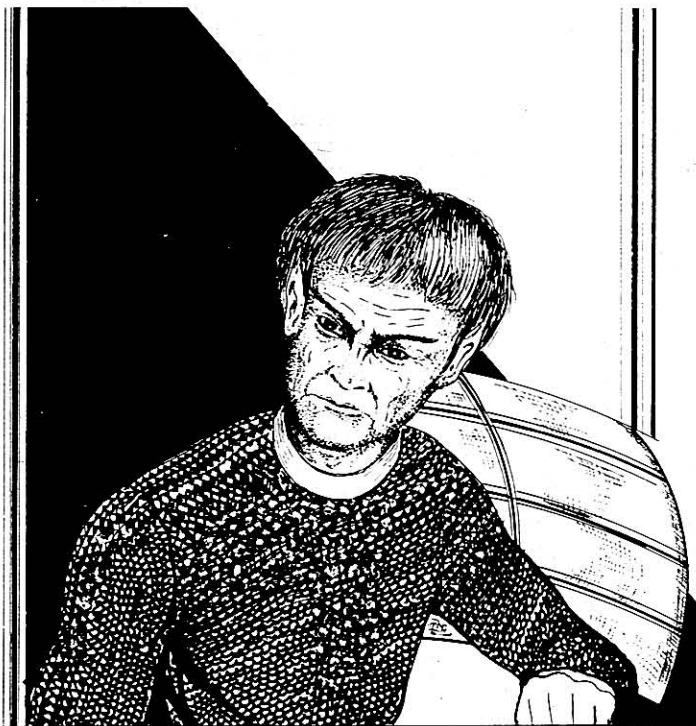

For civilian personnel who will agree to leave immediately, he will offer to settle all outstanding contracts, to pay all penalty claims against them, to give each 50,000 credits as hazard pay, and to pay all expenses. He further hints that certain government officials might look favorably on them with cargo contracts, and so forth, though he will not say so outright.

It is just possible that the players will guess by this time that Salak is not what he seems. They may even suspect that he is a Romulan, not a Vulcan. If Salak is accused, he will emphatically deny that he is anything but what he claims to be.

It will not be possible for the player characters to prove their suspicions. Salak will remain unemotional at all times. He cannot be tripped up by questioning. If a tricorder scan is requested, Salak will inform the player characters politely that such devices will not operate in the hotel room with the security field switched on, and he cannot turn it off until they leave, "for security reasons." Salak will refuse medical examination or other such intrusions, and he will not allow himself to be mind-melded, showing surprise if such things are suggested.

Ultimately, suspicious characters will have to either trust Salak (and Sonam) enough to go along or refuse the mission. Though they are intended to accept the mission, but they are free to decline. Certainly, the secretive nature of the job should make them all quite nervous. If the player characters accept, Salak will request that they return to their quarters, and the adventure continues as set forth here. If the player characters decline, the adventure is not spoiled, but proceeds as discussed in the **Revisions** section.

MYSTERIOUS PREPARATIONS

When the player characters return to their quarters, they will find that preparations have already begun. Star Fleet characters will find that a message has been received from a highly-placed Star Fleet Admiral, ordering the ship to lay over at their current port-of-call and await further orders. The message "strongly suggested" that extended shore leave be granted to all hands until further notice. If the captain is an NPC, he will be puzzled, but will comply with this suggestion.

If the players are civilian independents, they will find messages stating that arrangements are underway to settle on cargoes currently being carried. A receipt for extended berthing is enclosed, along with a bank draft for 1000 credits, drawn on a reputable Federation bank and easily convertible to cash or ID card credit at any local financial institution.

A FORTUNATE INVITATION

Within two hours, the lead character will be contacted by special messenger with an invitation to spend his shore leave on the private estate of his "old friend, Salak of Vulcan." The message says that the estate is on a small island several hundred kilometers from the spaceport. It further states that no direct transporter coordinates are available for this island, but tells that a private air transport has been chartered for the lead character and his friends from a small commercial airfield.

A gamemaster might have a bit of fun here if the message is delivered by an NPC known to the lead character, but one whom the players would not want along on the adventure. The NPC can then make an attempt to invite himself or herself along on the vacation. If the players can't find a way to ditch this pest, they'll have to take him along on the mission just to keep his mouth shut!

If the player characters check up on the island estate, they will find it is owned by a Vulcan cartel of merchants, but has not been used in some time. It is supposedly equipped with a huge mansion complex, a landing field for aircraft and small spacecraft, and terrific recreational facilities. The estate is quite well-known in the spaceport area, and so anyone who finds out the player characters are going there will be envious and surprised that they have friends who are rich Vulcan merchants.

A check at the private air charter service will confirm that a small aircraft has been chartered and awaits the lead character.

THE VACATION ESTATE

At the airfield, the air charter service will have the plane waiting. If any of the players are skilled aircraft pilots, they will be invited to pilot the aircraft themselves. Otherwise, a pilot will be provided for the trip. If the players question the charter service officials, they will discover only that the arrangements for the plane were made by a Vulcan gentleman who paid in cash. They will be assured that the pilot will be discreet and ask no questions.

The flight will take very little time. Upon arrival at the island's private airfield, the characters will be met at the strip by Salak. If a charter pilot flew the aircraft, Salak will pay him off, add a hefty bonus, and instruct him to leave without disembarking from the plane.

Salak will lead them to a hangar on the field, explaining that the mansion itself is still shut down, and that only this hangar has been opened and furnished for his use. It has, he will relate, a small office, attached private quarters, a dormitory-style bunkroom with automated food service, and a small spacecraft hangar.

Salak will usher the player characters into the office, which has only one unusual feature about it – an elaborate communications panel built into the desk. (Salak will refuse to answer any questions about this panel, again citing security as his reason.) He will conduct them into the common bunkroom and show them how to work the food processors. He will request that they settle in for the evening, stating that they will be leaving in the morning. He will put off all questions, requesting that these be held for the transit to Bonus Run. Then he returns to the office, locking the door behind him.

The player characters may decide simply to have dinner and get some sleep, but some may wish to sneak out and explore. They will discover that the bunkroom is sound-proofed, including the door to the office, the only way out. The player characters may leave the bunkroom, but if they exit the hangar building, open the door to the hangar itself, use the communications equipment concealed in the desk, or attempt to enter Salak's quarters, Salak will be alerted by an alarm that the player characters cannot hear. This is discussed in the section **A Silent Alert**.

The Way Out

The door is heavy, but is secured only with an old-fashioned mechanical lock mechanism. The door may be burned down with one noisy shot from a phaser set to disintegrate, if any player thought to bring one along. (Any openly carried phasers likely would be inappropriate for 'vacationers,' but it is possible that one could have been carried concealed.) Burning out the lock with a phaser set to heat will be somewhat quieter. No player character should have experience picking such an antiquated lock, but if someone wants to try, it will require a bent piece of wire, easily removed from the food synthesizer, and a successful Saving Roll against BOTH the LUC and DEX scores. Only one roll may be made per person, regardless of how many attempts are made.

The Office

If the office is entered, the players will find the desktop is bare. A search for the secret button releasing the communications panel can be resolved by a Saving Roll against the characters' LUC scores. If it is revealed, the panel will be seen to be equipped for long-distance, scrambled, subspace radio communications. A successful Skill Roll against the examining character's rating in *Communication Systems Operation* or *Communication Systems Technology* will reveal to the character that the console is equipped for receiving coded messages from Star Fleet, and he will know that such equipment ordinarily is not available to civilian personnel. Some of the unmarked settings will be unfamiliar to him, though, not being used normally by either Star Fleet or civilians.

The console can be operated by anyone with basic proficiency in *Communication Systems Operation*, but operating the equipment will reveal nothing. Using the unmarked, unusual channels will bring no response except Salak.

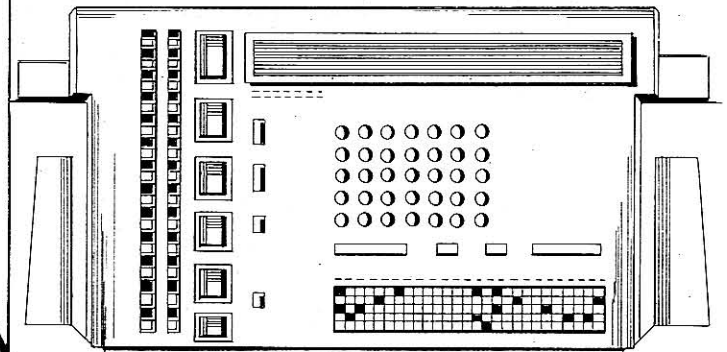

The Estate Grounds

The door to the outside is locked, but easily released from the inside. Nothing will be gained by exploring the mansion or other buildings, none of which are in use, just as Salak has said. No way exists off the island except the vehicle in the hangar. Salak will allow the player characters to waste time exploring, confronting them when they return.

The Hangar

The door to the hangar is not locked. Inside is a battered old ship with a cartoon of a big-eared furry animal painted on the nose. (Characters from Terra may recognize the beast as a koala bear.) The name "Terri Bear" is stencilled on the fuselage alongside a private Federation registry number. The ship is obviously one of many privately-owned *Mission* Class ships that have been converted for use as small cargo vessels. The player characters will not have time to enter the vessel before Salak confronts them.

A SILENT ALERT

If Salak has been alerted by the silent alarm system, he will enter the office a few moments later. He will be carrying a Phaser II pistol, set to wide-angle stun; he will use this phaser only if he is attacked.

Salak will confront the lead character, expressing disappointment, and he will offer to call for a plane to take the player characters home, if they desire. If they will stay, he requests them to return to their quarters. He asks them to choose immediately.

If the players have been foolish enough to cause an attack on Salak, he will fight back with the phaser, or hand-to-hand, if necessary. He will only protect himself, ceasing hostilities when the player characters do. If he is in command of the situation after the attack, he will insist on calling a plane and returning the player characters to the starport immediately. He will not explain anything any further, under any form of questioning or duress.

If the players are returned to the starport, and if they bring the planetary officials into the situation, THEY will be detained as trespassers, unable to prove otherwise. Salak will be released (under pressure from the local Vulcan trade council), and the players will be up to their eyeballs in hot water. The **Revisions** section details ways to continue the adventure.

If by some incredible blunder the players kill Salak, harm him, or otherwise feel the need to leave the island, the only way is with the ship in the hangar. Salak has booby-trapped the vessel, however, and if it is lifted without disabling the booby-trap, it will explode. The resulting matter-antimatter conflagration will destroy the ship and the entire island. Salak will not reveal the presence of this device even to save his own life. If the players hijack the ship, it's doom for all of them, which is nothing more than they deserve.

IN TRANSIT

THE DEPARTURE

If the evening is a quiet one, or if the explorers return to the bunkroom, Salak will wake the player characters early the next morning and take them aboard the ship, after opening the clamshell doors which form the roof of the hangar. Though the *Terri Bear* appears old and battered from the outside, the inside is clean, well-maintained, and modern. Salak will conduct a short tour, during which he will poke inside an inspection panel to disconnect his booby trap, only telling the players about it if they ask specifically what he is doing.

The bridge has helm, navigation, communications, and sciences consoles, plus a captain's chair. Helmsmen will see that most functions can be controlled from the helmsman's seat by a single pilot. The engineering area contains two engineering watch stations and a weapons console controlling a single FH-6 phaser. There are bunkroom facilities for an 8-man crew, plus an owner's cabin. The cargo hold contains 100 SCU of various unusual or luxury foodstuffs.

After the tour, Salak will make shipboard duty assignments according to the experience and training of the player characters. Salak can, in a pinch, serve as either chief engineer or helmsman/navigator, if necessary, but he will give those jobs to someone else, if possible. He will explain that, for most of the trip, only two people absolutely need to be working: a helmsman/navigator on the bridge and an engineer in the engineering area. He will assign the player characters to the bunkroom, taking the owner's cabin for himself.

After this, Salak will request that the ship be prepared for immediate departure. He will handle the helm himself for takeoff, lifting out of the hangar and through the atmosphere on landing thrusters, and activating impulse drives until the ship clears orbit. Despite the tight network of space traffic controls about this planet, no ground-based or orbital control centers will question the ship's actions. Once the ship leaves orbit, Salak will set course for Bonus Run and turn control of the ship over to the player characters. He will then retire to his quarters, asking not to be disturbed during the flight and promising to conduct a full briefing sometime before the 6-day flight at Warp 6 is concluded.



ENROUTE TO BONUS RUN

Unless the ship alters course or something else unforeseen happens, Salak will not be seen again until the ship is one day out of Bonus Run. During this time, the player characters will have the run of the ship without Salak's immediate supervision. The players may use this time to peruse the ship's library and relax, but they most likely will decide to snoop. Salak will not be pleased if annoyed with minor problems during this time, and will avoid all contact with the players, if possible.

The cargo is just as Salak described it, with nothing else unusual concealed. There are no weapons, tricorders, or portable communicators aboard, but there are civilian clothes and merchant-type ship uniforms stored in the crew quarters, sized to fit each player character.

The ship's computer banks contain the information given in **Background Information**. Nothing else is unusual, with the exception of one bank that is closed under a security code. Each player character may attempt to override the security code and gain access to the bank. To do this, the player makes two Skill Rolls, one each against his character's ratings in *Security Procedures* and *Computer Operation* skills at a penalty of 40 points subtracted from each. Each individual is only allowed one try to access the bank.

If the rolls are both successful for one individual, the bank will be found to contain a single text file in *Romlesta*, the Romulan tongue. Any character with a Skill Rating of 10 or more in *Romulan Language* can read the message; a character with a Skill Rating of less than 10 may make a Skill Roll against his rating in an attempt to read it. Any attempt to have the computer translate the message will cause the security system to erase the screen and lock the file irretrievably. The file reads as follows:

Terms have been agreed to, as per our conversation. Both groups will cooperate, or at least will not hinder. Arrangements have been made to get you Federation helpers, not of our organization, to avoid suspicion. Obviously, you must remain hidden or your quarry will run. Even this communication is unsafe, but perhaps in this language it will be more secure than in mine.

I do not agree with what you must do, but I know why you are doing it and why our leaders feel it must be done in this manner. I have learned to respect you. I wish you success in restoring what you lost. If anyone can help you, the persons I have sent you can.

Someday, when all this is over once and for all, may we meet again under better circumstances.

Sonam

BRIEFING

Salak will emerge from his quarters when the ship is one day out of Bonus Run and assemble the crew on the bridge for a briefing. He will explain that the *k'manatram* being pursued was once known as T'Lovus, a former officer in the Romulan space navy who rose through the Romulan system of local and regional senates to become a member of the Romulan Imperial Senate. T'Lovus' ambitions proved his downfall, however. He sought to obtain a seat as an Imperial Grand Senator by planting damaging evidence against one of his fellow Romulans currently holding that position, but he was caught.

Salak will explain that, though treason against an Imperial Senator ordinarily brings the death penalty in the Star Empire, the crime of betrayal for ambition was judged greater, and brought the greater penalty — declaration of *k'manatram* status. This brought about the loss of all T'Lovus possessed or could ever possess. His family, friends, and former shipmates all refused to acknowledge his existence, and all records of his birth, service, and very existence were wiped out. Thus he became an invisible, intangible nothing, a person who never had existed.

Salak will state that most *k'manatri* die, many at their own hand, but a very few are hardened by their experience, and manage to stay alive long enough to leave Romulan space. Of these, some try to perform a great task to further the Romulan cause to win back their honor; in Romulan history, only a handful have been taken back into their society, and most of these were redeemed only by their deaths.

He will point out that T'Lovus seems to have become embittered, which fact the Federation hopes to turn to advantage.

The renegade has been tracked to Bonus Run, where his ship came down near Bonus Run Center, the planet's major city. There he evidently sold instruments from his ship on the black market. Though one black marketeer was caught, the trail led nowhere. Another local black marketeer, an Orion named Cevlac Loban, is known to be capable of moving starship instruments of dubious ownership, but he has not yet been questioned.

THE PLAN

Salak will then outline the plan he has for finding the Romulan outcast, a plan complicated because he is known on Bonus Run, and so he must stay aboard ship. He will reveal that he has been briefed on the renegade's habits and capabilities, and will direct the players' search in secret.

The player characters will pose as independent traders supposedly smuggling the luxury foodstuffs in the cargo hold to cover their real mission on Bonus Run. Transport of such foodstuffs requires certification of purity in both the UFP and Orion markets, certification the crew of the *Terri Bear* will pretend not to have. Salak explains that the only way to sell such a cargo would be to contact the black market, and making such contacts will be their excuse for inquiries that may lead them to the renegade Romulan.

Salak is sure the Orion-run tradeworld will accept them with little question. The world has many traders, most with business on the somewhat shady side. None of the player characters has ever been here before, which will lessen the danger of their cover being blown. They are to start by negotiating the sale of their somewhat illegal cargo, asking a few questions of the locals. This is to be done by drawing as little attention as possible to them. The player characters are to report back to the ship each evening, in person if possible, to share their findings with Salak. Once the whereabouts of the renegade are established, Salak will come up with a plan to trap him, and will accompany the players when they confront him to present the Federation's proposal.

The player characters are to dress in civilian garb. If they need weapons, he has enough phaser I pistols in his cabin for the whole party. He also has two tricorders and two scrambled, secure communicators in his cabin, which he will hand out. He will distribute the fake IDs he had prepared for the player characters, using their own names but providing phony backgrounds. He will relate that the ship itself is registered out of a Federation tradeworld and will not arouse suspicion.

Finally, he will suggest that they spend the rest of the day familiarizing themselves with their roles, the background information on Bonus Run, and the files he will provide their quarry. This information is found in the section on **Background Information**, some of which could have been provided earlier. Do NOT provide the character data record for T'Lovus to the players.

ARRIVAL AT BONUS RUN

When the ship approaches Bonus Run, Salak will leave his cabin and return to the bridge. If necessary, he will land the ship at the Bonus Run Center spaceport, but preferably this should be done by the player characters. In either case, he will require the player characters to make all communications with Ground Control. After landing, Bonus Run Port Control will inform the crew of the *Terri Bear* to expect a routine port entrance inspection. Salak will give the lead character a small, sealed envelope, with instructions to give it to the port inspector when he comes on board. He will then retire to his room.

The sealed envelope holds 300 Orion credits and a note in the Orion tongue stating that there is more where that came from if the appropriate arrangements are made for berthing the ship, clearing the cargo, and cutting through the red tape. Whether or not the envelope is opened will make little difference to the adventure as a whole, but whether or not the lead character follows Salak's instructions will.

GREASING PALMS

A large ground car arrives minutes after grounding. The scarred, tough-looking Andorian driver's dusty-blue skin clashes with the bright orange jumpsuit he wears. His passenger is an obese Orion male dressed in grey, with an orange sash that is decorated with an elaborate circular design in silver and orange, obviously the corporate/family mark, probably that of the Delfi family corporation which operates most of Bonus Run. The plump Orion will introduce himself by intercom as Port Inspector Clev Davra and request admittance for himself and his driver for routine inspection.



Once on board, Davra will prove to be an officious, self-important pain in the neck. He will chatter about his relatives in the Delfi family (he is wedded to a Delfi cousin), try to impress the crew with his position, and find fault with everything. Dealing with him is quite simple; it is merely a matter of greasing his palm. If the lead character hands him the envelope, as instructed by Salak, nothing will be simpler. If not...

If forced to inspect, Davra will find a series of minor infractions, imposing a 5- to 50-credit fine for each. If he gets as far as the cargo hold and finds the cargo, he will ask to see the crew's purity certification papers. When he finds out they don't have any, Davra will sadly inform the crew that the cargo will then have to be confiscated 'for destruction.' He will insist that he must summon the disposal team immediately, but will stall and hint, still looking for a bribe. If he still doesn't get it, he eventually will get mad and leave, sending a disposal team (with armed guards) to take the cargo.

If given the sealed envelope, Davra will open it. If given less than the 300 credits originally in the envelope, he will openly demand more. But, given the proper bribe, he will leave right away, bowing very politely.

Soon after Davra leaves, work crews will arrive to fit a dolly to the ship and move it to a safe corner of the spaceport. A message will be radioed that the port's cargo handling facilities are now made available, and that the captain can request the cargo be off-loaded at any time onto a rented ground vehicle for his use in Bonus Run Center. The official suggests that the captain not call for this vehicle until the cargo sale has been arranged, however, as the port only has a limited number of them available.

HITTING DIRT

A messenger will bring a sheaf of papers that releases the cargo for immediate sale and admits the crew to Bonus Run Center. Once these papers are signed by the captain, the messenger will state, the crew is free to 'hit dirt' and go wherever they desire.

The player characters can tie into the local communications and data network. Doing so will automatically feed them a visitor's bulletin, which includes a file on Bonus Run and general maps of the port and the surrounding city of Bonus Run Center. This information is already in the ship's computer, but the players may not have looked. Furthermore, if the players don't bother to hook in with the local network, they will find a vending machine just inside the port terminal building which sells (5 credits; ID/credit card acceptable) the same information on a standard computer/tricorder cart.

The information will tell that the port (and most of Bonus Run) is run by the Delfi family corporation, which is well known. Information on this family corporation is provided in the ship's computer banks, or can be accessed from the local data network. Information on the head of the family, Kaylo Delfi, is available only from the ship's computer banks. All this information is presented in the **Background Information** section.

The information will confirm that Bonus Run Center is like most tradeworld spaceports, with its culture and customs heavily influenced by the high transient population of traders from nearly every part of the known galaxy. The city is roughly divided into areas called quarters, each with its own look and population. The spaceport is a large rectangular area roughly in the center of this development.

For play, maps of the spaceport, the city, and several key establishments have been provided. Random encounter tables are provided for each of these areas; these should be used whenever a group of characters enters one of these areas in search of clues or in transit toward a specific location in that area, as described in the **Gamemaster's Notes**.

BONUS RUN CENTER SPACEPORT

The spaceport has a dingier look than most tradeworld centers, and the other traders who can be seen there aren't exactly the top of the line. The public sections of the port will have a lot of Orions present, mostly of the dominant race, though a few green women, never unaccompanied, are in evidence. Humans, Andorians, Vulcans, Tellarites, and a few Klingon traders also will be seen; few are unarmed.

Leaving and entering the port facility can only be accomplished at the main gate and the north gate. It is possible to pass through the port facility enroute between two locations, but only at these gates.

PORT TERMINAL BUILDING

Trading Post

The terminal building, which is near the main gate, has a small trading post where most common items (including electronic devices and small hand weapons like disruptors) can be purchased at about 1½ times their normal value.

The Spaceport Bar

A good-size bar-restaurant, run by the Delfi Port Company, has prices that are just as high as the trading post and food that is only moderately worth eating. It features a small stage with green Orion dancers, guarded by a good-sized contingent of burly Orion bouncers. The bar, busy most of the time despite the high prices and low quality, is patronized mostly by traders. Even so, the place generally is quiet, because the management, which doesn't like trouble, runs most

of the planet, and so a trader will think twice before starting a fight.

The bartender, a friendly sort named Volo Kladl, is another distant Delfi cousin-by-marriage. Kladl is somewhat dissatisfied with the way Kaylo Delfi has been running things of late, and he doesn't care who knows it (which is how he ended up tending bar instead of getting a more important job). In the course of bar chatter, he will relay quite a bit of information to the player characters, the only useful data to be gathered in the port terminal.

It is Kladl's opinion that the port seems to have been attracting "a lot of losers" over the past eight months or so. He will relay that customers say business is not as good as it once was (his has not suffered any), and several big firms have been hurt by the Delfi family's economic manipulation. Many people are out of work, he will say confidentially, and, though many traders are taking their goods elsewhere, Kaylo's hold on the family business is still quite tight, despite his having been even more reclusive than usual recently.

Kladl can give directions to most anywhere in the city, if the players tip him at least 5 credits. If he is not tipped, he smiles a lot and pretends not to know very much. If asked about Cevlac Loban, Kladl will say he does not recognize the name, but that most anything can be found by asking around at the Shadow Market.

RANDOM ENCOUNTERS

The only random encounters in the spaceport will occur when any individual player character or group of characters enters or leaves through one of the gates. For each encounter, roll 1D10 and consult the table below. Because each encounter type may occur in other locations, their descriptions are collected in the **Gamemaster's Notes** section.

Random Encounters In The Spaceport

Die Roll	Encounter
1 - 6	No encounter/nuisance encounter
7 - 9	Legitimate street dealer
10	Bureaucratic hassle

THE VISITORS' QUARTER

This section of town is completely dominated by transients and those who buy from, sell to, or prey upon such visitors. The area abounds in gift shops, bars and taverns, hotels (cheap to moderately priced); and various tourist traps. One must pass through this area to get to the Shadow Market.

There are no planned encounters here, but characters who buy drinks or tip a bartender in a local pub, make a purchase in a shop, or check into a hotel can usually get help locating the Shadow Market or any other locale they seek.

LOBAN TRADE ADVISORS

Do not describe this establishment unless the player characters have been directed here through role-play.

This establishment is unidentified save for a sign that reads simply *Trade Advisors*. Inside, the front office holds a secretary, a nervous-looking Orion who appears to run the establishment, two younger, stronger types who seem to just hang around, and several customers. Customers are not dealt with in the front office, but are asked to step into a back room with the proprietor to state their needs.

The proprietor, who does not introduce himself, is Cevlac Loban; the musclemen in the front office are his sons. A local black marketeer, he will state a willingness to discuss any trade arrangements the player characters have in mind.

clients for a fee. He will, however, not ask for this fee or discuss it. He has some very useful information for the player characters, however, and will tell it to them if they ask the right questions.

Any threat to Loban during the player characters' meeting in the back office will be met by his two sons, who have been watching via a hidden camera. The sons will enter armed with hand disruptors; these are the Romulan version of the Klingon Mark I, and are traceable to T'Lovus' ship. The young men will use the weapons to protect their father, if necessary. If Loban is killed, the sons know nothing that will help the characters. If the sons are killed, Loban will never give the player characters any help.

Selling The Cargo

If the player characters are attempting to sell their cargo, Loban will ask what the players were offered by other dealers. If the players tell him, and their quote is less than 650 credits per SCU, he will better the offer by 50 credits per SCU, explaining carefully that they can get that much if they know where to look, and he'll be all too happy to tell them where to find such a buyer. If they claim they were offered more, he will shrug and say "That's nice; you should have taken it. I can't offer more than 650." Either way, if the player characters bargain a little (and make a successful Skill Roll as discussed in the **Gamemaster's Notes**), they can get the price up to a maximum of 750 credits per SCU.

If the player characters agree on a price, he will tell them to deliver the cargo to a warehouse (actually his own, though he would deny this) in the quarter known as The Pit. He will not go with the players to this place, but promises someone will meet them there at any time specified for delivery.

Purchasing Starship Instruments

If the player characters ask about starship instruments, he will offer to show them samples, including a few Romulan developments that might be of use. He will relay that the instruments are "samples from the consignment of a customer" who asked his advice on how to sell them. The 'samples,' of course, are instruments sold to Loban by T'Lovus. If a purchase is concluded, Loban will have them transported to the warehouse for delivery, just to preserve his cover story as a trade advisor.

If a character with a Skill Rating of at least 5 in *Romulan Language* examines the samples, he will recognize the Romulan markings. A character with a Skill Rating of at least 10 in *Starship Sensors* will be able to tell that the instruments are advanced sensor devices not of UFP manufacture. Furthermore, a successful Skill Roll against the rating in this skill will reveal that the sensor equipment is of excellent quality.

Loban will state that the whole setup includes sensor antennas, control computers, and readout equipment and bulks about 30 SCU. He will offer to sell it for a total of 150,000 credits. This price is actually a bargain, since the equipment is some of the latest in Romulan design, and could be sold for much more either to the UFP or to a private starship builder, but only a character with a Skill Rating in *Starship Sensors* greater than 40 would know this. Loban simply hasn't been able to find a buyer willing to risk smuggling the stuff, and if the player characters bargain well, they can get it for as little as 80,000 credits. If they get close to this figure, Loban will finally offer to trade even up for the luxury foods cargo.

If a deal is concluded, Loban will give the address of his warehouse in The Pit as the location of the instruments, and say that a meeting there within several hours is possible, if the player characters want.

Inquiring About T'Lovus

If a player character mentions T'Lovus, renegade Romulans, or Romulan outcasts, he will hit the jackpot, one way

or another. Loban met the renegade soon after his arrival in Bonus Run Center. He purchased the stolen ship and still seeks a buyer for parts of it. T'Lovus used the money to make important contacts, supposedly getting in with the Delfi Corporation somehow. Now, T'Lovus will have nothing to do with Loban at all!

Needless to say, Loban is disgusted with T'Lovus. He will be glad to help anyone who wants to hurt T'Lovus. Conversely, he will be as glad to boot out anyone who professes to be a friend of the renegade. Loban knows what T'Lovus looks like, but has no pictures. He will describe him as having longish black hair, a hawk-like face, and "those damned ears."

He will not cooperate to the extent of accompanying the characters on a search, but will suggest that the renegade "was in good with corporate security people" for the Delfi family corporation's offices. He will relate rumors that T'Lovus has been supplying drugs to people in the Delfi organization, though he cannot confirm the stories. He will suggest that an "apothecary" named Uvane, with a shop in The Pit, might know more about that, and he will tell the player characters where to find Uvane's shop.

The Delfi Family Corporation

The black marketeer will state that he has a low opinion of the Delfi family corporation, which in recent months has become a haven for scoundrels and thieves. Loban will say he still has some legitimate dealings with Delfi's small lot brokerage, which is run by Toora Delfi. Toora, he says, heads the branch of the family opposing Kaylo, who runs the family corporation. Toora's influence is limited, however, and Loban will say that he does not trust the company for the most part.

RANDOM ENCOUNTERS

Rolls for random encounters should be made upon entering and every four squares (16 city blocks) or so. Roll 1D10 and consult the table below to determine encounter type.

Random Encounters In The Visitors Quarter

Die Roll	Encounter Type
1 - 5	No encounter
6 - 7	Pickpocket attempt
8 - 9	Legitimate street dealer
10	Illegal offer, bogus

THE SHADOW MARKET

This area is much different from the open bedlam of the High Market. People, many alien and most shady-looking, mill about, but no one seems very anxious to do business.

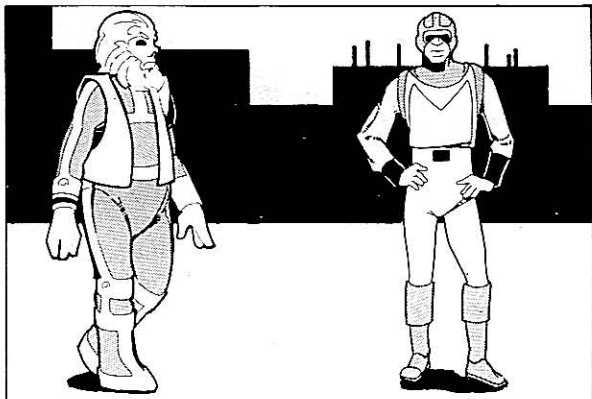

Sooner or later the player characters will probably come here seeking Cevlac Loban, either directed by bartender Kladr, by some other well-informed helpful local, or by Salak himself (if the player characters seem to be getting nowhere).

PLAYER-INITIATED ENCOUNTERS

Most transactions in The Shadow Market occur between people who know each other only by sight. All traders there expect to be approached, and few will actively pursue a customer, which accounts for the appearance that no one is interested in doing business.

The typical procedure for selling something illegal is almost like a ritual, and may be observed by the player characters if they watch long enough. This same procedure would be followed for the purchase of illegal goods, altered only in who ultimately ends up with the goods and who with the money. This procedure should be used whenever the player characters attempt to sell their illegal cargo, find Loban the black marketeer, or make any contact in The Shadow Market. If the characters have a Skill Rating of at least 40 in *Streetwise*, they will know this procedure. If not, and they watch things long enough, discreetly of course, they will observe the procedure and be able to mimic it should their skill in *Streetwise* be little to nonexistent. If they blunder into negotiations without following the procedure, they should learn it through role play (potentially very funny). The procedure is this. Trader A, who wants to sell an illegal cargo, will approach Trader B and casually ask if anyone has been buying that commodity recently. If Trader B doesn't know Trader A, he can be seen to appraise Trader A before answering; no names are exchanged, as a rule. (In effect, Trader A makes a Skill Roll against his rating in *Negotiation/Diplomacy*.) If Trader B does not like what he sees (the Skill Roll was not successful), no information will be forthcoming at all, and Trader A will have to move on. If Trader B likes what he sees (the Skill Roll was successful) and he is interested in the goods, he will make Trader A an offer on the spot, and negotiations will begin in earnest. If Trader B thinks Trader A is all right, but he has no interest in Trader A's goods, he will tell Trader A that he might know of someone who is interested. Now, Trader A slips Trader B a bribe of 5 to 50 credits (depending on the total sale price, on need, on illegality of the goods, or on Trader B's good looks). Then Trader B gives Trader A directions (no names) to the location of Trader C, who might be interested. If Trader C is a local broker, Trader B will get a percentage of the profits from any trade he brings or sends in.

Searching For Loban

In the Shadow Market, names are never exchanged, particularly family names. Nicknames are often used, however, particularly between traders who know one another (at least by sight). Thus, if the player characters ask for someone by name, their contact will not get particularly upset. He is, however, likely to say "Never heard of him..." In the subsequent conversation, if the contact is feeling particularly helpful (successful Skill Roll against the rating in *Negotiation/Diplomacy*, plus a small bribe), he may continue by saying, "Now I do know of this person you should see..." and proceed to tell the player characters how to find the person they were looking for in the first place.

Selling The Cargo

If the player characters inquire about selling their cargo of luxury foods, they will find that most street traders can negotiate such a sale. They will offer about 250 credits per SCU, but this can be worked up to a price 550 credits per SCU, for a total of 55,000 credits. The procedure for this is given in the **Gamemaster's Notes**.

The player characters will frankly be told that that is well below it's market value, but that few locals have the contacts

to obtain forged health certification papers. If the player characters insist on more, they will be directed to the Visitors' Quarter, to an office with a sign reading *Trade Advisors*. (This is Loban's office, but the player characters should not be told this.)

Buying Starship Instruments

Player-character inquiries about purchasing any kind of spacecraft parts or instruments will get the player characters directed to Loban's office automatically.

RANDOM ENCOUNTERS

Rolls for random encounters should be made upon entering and every four squares (16 city blocks) or once per 15 minutes. Roll 1D10 and consult the table below to determine encounter type.

Random Encounters In The Shadow Market

Die Roll	Encounter Type
1 - 5	No encounter
6 - 7	Pickpocket attempt
8 - 9	Black market broker
10	Illegal offer, bogus

THE PIT

This part of town, aptly named, is an area of narrow, twisted streets that are shadowy even at noon. The worst dives are found here, as well as any kind of vice imaginable. Even Delfi company security, the closest thing to police on Bonus Run, do not come into this part of town for anything less than a major riot. The Loban warehouse is located in The Pit, as is the Uvane Apothecary.

When the player characters venture here, an encounter roll is made upon entering and once every 15 minutes or so. Player characters who enter a bar or dive had better watch themselves, because if they get into any trouble here they will have to get out by themselves. There is a base 50% chance that their presence will start a fight with a like-numbered group of Klingon or Orion bar toughs; this may be avoided if the player characters (as a group) make a successful Skill Roll against their leader's rating in **Negotiation/Diplomacy**.

THE LOBAN WAREHOUSE

This run-down warehouse is actually the trading center for Cevac Loban's shady operations as a broker for illegal cargoes. If any arrangement has been made with the characters to do so, Loban and his son Dabal will meet them here.

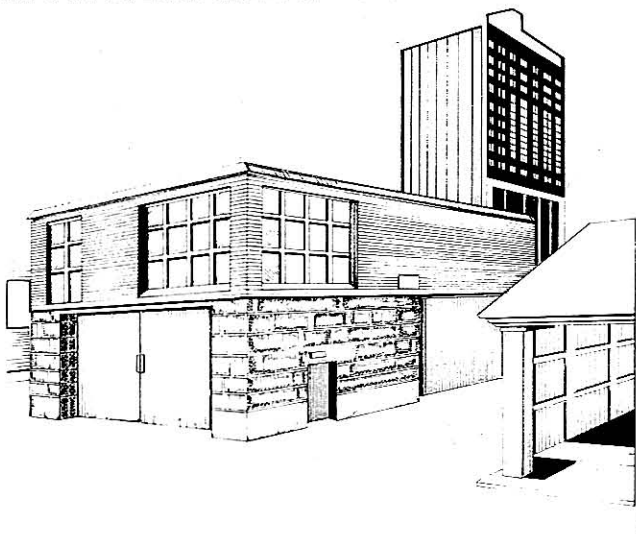

If the player characters have not already talked to Loban about the Romulan renegade, they may do so now, getting about the same reaction as described in **The Visitors' Quarter** section. He will again mention the apothecary Uvane, who had dealings with the renegade, and will note that the apothecary's shop is only a few blocks away.

THE APOTHECARY SHOP

This place is a real anachronism in *STAR TREK's* time, so much so that characters who are not medical doctors or history buffs may have to have the word *apothecary* explained to them. (An apothecary is a dealer in herbs and other nostrums used for medicinal purposes, the old-fashioned equivalent of a pharmacist.)



Telltale Powder

A Tellarite dressed like a trader will exit just as the player characters arrive, bumping into one of the player characters in his rush to leave. He will drop a small jar, which pops open and spills a greenish-yellow powder on the sidewalk. The Tellarite will become quite excited and abusive. He will not fight with the player characters, but will be very nervous and angry as he frantically tries to scrape up the powder. None of this action can be seen by anyone inside the shop, as the door is out of direct line-of-sight, and all the windows are covered with curtains. Finally, looking about as if afraid someone else will come along, he will leave the job half-done and run off.

If the characters examine the spilled powder, they will find it has a sharp odor and an extremely strong and sour taste. The examiners have a chance to recognize the powder. For each who has a Skill Rating in *Streetwise*, ask the player to make a Skill Roll against the rating minus 20; for each character who has a Skill Rating in *General Medicine, Human*, ask the player to make a Skill Roll against the rating minus 40; similarly, for each character who has a Skill Rating in *General Medicine, Tellarite*, ask the player to make a Skill Roll against the rating minus 40. If any roll is successful, the powder will be identified as *fleh*, an uncommon Tellarite narcotic that also works on Humans, illegal in most areas.

The Apothecary

Within, the small shop is as old-fashioned as its function; a map is provided in the **Maps** section. The gamemaster should make a secret Saving Roll against the INT score for each player character entering. If the roll is successful, the character will have noticed that the shop seems to be quite a bit smaller on the inside than on the outside.

The walls behind the long counter are filled, floor to ceiling, with jars, bottles, and boxes, all meticulously labeled in a language likely unknown to most player characters except professional physicians or pharmacists. Even the shop's computer terminal is housed in a casing that looks like an ancient cash register.

The proprietor is a wizened little Orion of advanced years who will quite pleasantly identify himself as Jaclan Uvane. Uvane will be quite friendly and helpful. If asked, he will explain that he is merely a dealer in herbal medicines and caters mostly to an Orion trade, though he will be glad to serve anyone who enters.

Inquiring About Illegal Drugs

If questioned openly about illegal drugs, Uvane will deny knowledge. If questioned discreetly, he may be more receptive. This is one occasion where a strong, threatening presence may help the player characters, if they don't overdo it. If threatened or confronted with the powder collected from the incident outside the store, however, Uvane will admit that he "moves a little powder, now and then." Though Uvane is amoral, he is not a fighter; if threatened by people he believes can back up their threats, he will cooperate until he has a chance to do something about it. Uvane will insist that he isn't a big-time drug dealer or smuggler, a falsehood. He will claim he simply picks up a bit here and there from traders coming in and resells it. He will stick to the story as long as he can.

Inquiring About Romulan Renegades

Unless he is thoroughly intimidated, Uvane will claim to know nothing about any Romulans. If pushed, he will admit to having secured drugs from traders who operate along the Romulan border, but he will say that he does so under orders and doesn't know exactly what he was obtaining. Uvane will claim to have little real knowledge of drugs and chemistry (again, a lie), selling only what he can buy from traders he knows are trustworthy.

Once Uvane is properly scared, however, he will talk about his relationship with T'Lovus. Uvane will claim he has never seen the renegade, working only through messengers from within the Delfi family corporation (another lie). He will state that he never calls "The Romulan," and when he wants Uvane, he sends a messenger.

If the characters tell Uvane that they want to contact T'Lovus, he will offer to set up a meeting, if they will leave him out of it. If the characters agree to this right away, he will ask them to get lost for awhile, and meet back here in two hours. The results of this action are detailed in **Trap!**

The Back Room

If, however, the characters stay around for awhile, or search the place, they will smell smoke after a few minutes. Uvane will panic when he notices this, and yank several bottles off a shelf behind the counter, triggering a hidden mechanism that rotates part of the shelving to reveal a hidden doorway. Behind it, a room will be revealed containing a complete modern chemical synthesizing setup. A back door stands open, leading to a darkened alleyway, and a fire rages around the machinery. Uvane will scream and rant about "that blasted coward" and shake his fist at the open door. If someone runs outside, they will find no one to pursue.

A nearby fire extinguisher can be used to douse the flames. Unless the player characters have specifically stated that someone is physically restraining Uvane, he will escape in the confusion.

Once the excitement has died down, the player characters can examine the area if they wish. The fire has damaged most of the equipment, but it is obvious that this was a small manufacturing setup of some sort, likely involved with purifying or synthesizing drugs. The machine's output hopper has been removed, and will be found dumped in the lab sink. It and the sink have been thoroughly rinsed. Some kind of reddish-brown dust does cling to the socket where the hopper was attached, but it would take a close inspection (or a successful Saving Throw against a searching character's LUC score) to notice it. The dust, if found, will not be familiar to any of the characters.

If Uvane is still present (he won't be, if he can help it), he will try to deny he knows what was being made, but he will fold quickly if the player characters are at all insistent. He will admit, finally, that he was paid by T'Lovus to make some sort of drug out of materials Uvane was instructed to buy from border traders. He does not know the properties of the drug, exactly, but says the chemical structure is similar to that of a number of mild hypnotics and hallucinogens.

If Uvane is gone and the player characters find it, they can take samples of the drug. A tricorder will identify the substances involved in its manufacture, but it will take a ship's computer linked to the planetwide data network to search out chemical structures for comparison and determine that the drug is probably induces hypnotic, suggestible states. If the tricorder scan is analyzed by a botanist (Skill Rating in *Botany* of 40+) or if such an analysis is conducted by the ship's computer linked as above, the analysis will reveal the presence of certain plant extracts known to be common only within the Romulan sphere of influence.

By the time the back room has been searched, a crowd will have begun to gather, and the player characters will realize that it is probably unhealthy for them to stay. The crowd is pretty thick and unruly, and the crew will have to push through them. If the player characters attempt to take Uvane along, he will pull free in the crowd and escape.

RANDOM ENCOUNTERS

Roll for encounters in The Pit when the quarter is entered and every 15 minutes the player characters spend on the street. Roll 1D10 and consult the table below.

Random Encounters In The Pit

<i>Die Roll</i>	<i>Encounter Type</i>
1 - 3	No encounter
4 - 6	Pickpocket attempt
7 - 8	Illegal offer, legitimate
9 - 10	Illegal offer, bogus

THE FINANCIAL QUARTER

DELFI CORPORATION OFFICES

The offices of the Delfi Corporation are located in the largest building in the Financial Quarter; any Bonus Run native and most repeat visitors can give directions to them. The office building is modern and attractive in appearance. Like most Orions, the Delfi leaders seem to be concerned with the image of prosperity they put forth, even to casual visitors.

The main lobby is lush with comfortable chairs and couches, exotic ornamental plants, and even a fountain. There are four identical booths spaced across the reception area. On only one is there a lighted sign with the word *INFORMATION* displayed alternately in 12 languages; the other three booths are closed.

At the open booth, a Tellarite trader is talking to a bored-looking Orion dressed in Delfi orange. If the characters approach and get in line behind the Tellarite, they will be able to hear the conversation, and if they do not, soon the conversation will become loud enough for them to hear anywhere in the lobby.

The Angry Trader

The Tellarite is attempting to explain, rather impatiently, of course, that he has a cargo at the port awaiting off-loading instructions. He will tell the Orion that his deal with Delfi calls for him to deliver such a shipment every seven months,

The Tellarite, of course, will be furious, slipping into his native language in his anger as he rants and raves. (The Tellarite language is a wonderful language to curse in.) He will threaten to drag the Orion out of the booth by his "lying tongue," which he proposes to tie in a bow knot. In retaliation,



and he has the latest one ready. The Orion will glance at an electronic clipboard and flatly inform the trader that his records show no acceptance order for such a shipment, and that there is no one available to talk with him at this time. The official will suggest that the trader call the trade offices next week and make an appointment if he wishes to pursue the matter further. He will then call for the next person in line, waving to the player characters half-heartedly if they happen to be nearby.

The Tellarite, of course, will be furious, slipping into his native language in his anger as he rants and raves. (The Tellarite language is a wonderful language to curse in.) He will threaten to drag the Orion out of the booth by his "lying tongue," which he proposes to tie in a bow knot. In retaliation, the Orion will order the Tellarite to leave before he calls security. The Tellarite will grab for the Orion, only to find that there is a mild security field across the front of the booth. He will get a jolt and sparks will fly. The Tellarite, barely containing his fury and realizing he can do nothing further, will stalk out in a flurry of juicy curses in his native tongue.

Pursuing The Tellarite

If the characters decide to follow the Tellarite, they may do so, but he will talk to them only if they can successfully calm him down. One player may make a Skill Roll for the group, rolling against his character's rating in **Negotiation/Diplomacy**. If the roll is successful, the Tellarite will calm down enough to be rational and the player characters may learn something useful. If the roll is unsuccessful, the Tellarite will growl at the player characters too and be totally uncooperative.

The Tellarite will introduce himself as Cargomaster Glimph of the Tellarite-registry trader *Galfan's Pride*. For the last several years, he will relate, his firm has had an exclusive deal with the Delfi family corporation to supply them with refined copper, used in some local Delfi-owned manufacturing plants. He has been bringing in a shipment from a distant mining world about every seven months, at a price which is just a bit under the going rate locally. Glimph will state that

the arrangement has been good for everyone, but now Kaylo Delfi is backing out of the deal, for no reason Glimph can figure out. This means that Glimph will have to broker the shipment out piecemeal, and will probably end up losing money on the deal, a fate no Tellarite trader wants to contemplate. He will snarl for awhile longer about the way everyone at Delfi has suddenly gotten "quieter than a Vulcan with a new book," and then he will excuse himself to get over to the High Market and start lining up small lot brokers.

If the player characters have seemed interested in what Glimph has to say and perhaps have buttered him up a bit, he will tell them, "as one trader to another," that the only Delfi worth talking to on Bonus Run is Toora Delfi, at the firm's Small Lot Brokerage. "He'll dicker you out of your back teeth," says Glimph, "but at least he'll do it politely."

The Information Booth

If the group approaches the information booth without talking to Glimph, the booth official will be cool but polite. He will tell them that there is no way that *anyone* gets to see *anyone* at Delfi without an appointment. If asked for an appointment, he will state that he can not make an appointment, because that is the appointment secretary's job. If asked where the appointment secretary is, he will state that the secretary cannot be disturbed, and that the player characters should call him for an appointment next week. The player characters will get nowhere here.

If the characters have gone off with Glimph and come back, the booth attendant will be downright nasty, relying on the security field to protect him from them as it did from the Tellarite. After a point, he will simply refuse to deal with the player characters at all. He will call guards if they give him too much trouble.

Watching The Lobby

If the player characters sit and watch the lobby for an hour or so (roll encounters twice during this time), they will see many people come and go, but no one who approaches the booth seems to come away happy.

The Elevator

The only people who actually get into the main building are a few Orions in Delfi orange sashes or uniforms. These people simply approach one wall and wait a moment. Soon an elevator door opens, and they enter and are gone. There is no visible elevator control. The characters could try all day to enter an elevator, but the almost-invisible doors, controlled from within the building and monitored by hidden cameras, will not open for them. If the player characters try to bully or bluff their way onto the elevator, the booth attendant will call security guards. Security guards, armed with a phaser II set on stun, will arrive (one per player character) and eject them from the building.

RANDOM ENCOUNTERS

Random encounters in the Financial Quarter should be checked for when it is entered and every 30 minutes or every 6 squares of travel thereafter. Roll 1D10 and consult the table below. If the characters are on their way to the Delfi Corporation offices and don't have directions, they will wander around for some time before locating it. Roll 1D10 and multiply by 10 to determine how long this is, checking for random encounters as appropriate.

Random Encounters In The Financial Quarter

Die Roll	Encounter Type
1 - 5	No encounter.
6 - 8	Delfi Corporation guards.
9 - 10	Pickpocket attempt.

RESIDENTIAL QUARTER

SUSPICIOUS CHARACTERS

The residential area of the port is not frequented by traders very often, and the player characters would notice that a person dressed like a typical trader will stand out like a sore thumb. Traders tend to be unaware of and usually unconcerned with local fashion trends, sometimes dressing rather outlandishly. The player characters, of course, have been provided with clothing to match their cover as offworld traders. Thus, their presence, especially in a large group, will be noticed unless they are careful.

Even if the player characters take special steps to be unobtrusive or to cover their tracks, they will attract attention if they ask about the Delfi family estates. Every time they make an inquiry about the Delfis, they may appear to be "suspicious characters asking a lot of questions." If the questioner uses his skill in *Streetwise* (do not coach him to), the player should make a Skill Roll against his character's rating in *Streetwise*, with 10 points subtracted from the rating. If the roll is successful, then no suspicions will be aroused. Otherwise, there is a 25% chance the contact will be reported to *both* branches of the Delfi family.

This will make *both* sides nervous, which will reflect in any encounters with Delfi family members, corporation officials, or corporation guards. For any Skill Rolls made against a character's rating in *Negotiation/Diplomacy*, subtract 20 from the rating before making the roll.

The Delfi estates will not be difficult to find without asking, for the family crest and orange sash on the security guards are conspicuous.

KAYLO DELFI'S ESTATE

This estate is big, as befits the man who is in control of an entire planet. Surrounded by a ten-foot high wall with four uniformed, armed Orion guards at the ornate metal gates, this is not a place the characters are likely to try to break into. The metal gate appears to be a sturdy, but otherwise quite ordinary, decorative wrought iron grating, swinging open by remote control from within the guard shack just inside it. There is a public park across the street.

Security Arrangements

Actually, the security of the estate is more formidable than it looks. An invisible security field extends above the tops of the walls for about 8 feet, which will block passage and deliver a shock doing 3D10 points of stun damage to an intruder. It will also set off loud alarms and summon 2D10 guards.

The gate is hullmetal and proof against anything short of a phaser cannon. The button inside the guard shack only signals security personnel inside the estate itself who can see the gate through hidden cameras. It is *these* security guards who actually control the opening and closing of the gate, and they will not open it, even if signalled, unless they recognize the people at the gate. It is possible for either set of guards to turn on a security field similar to the one above the walls that extends across the gateway entrance, though this field is usually turned off during the day.

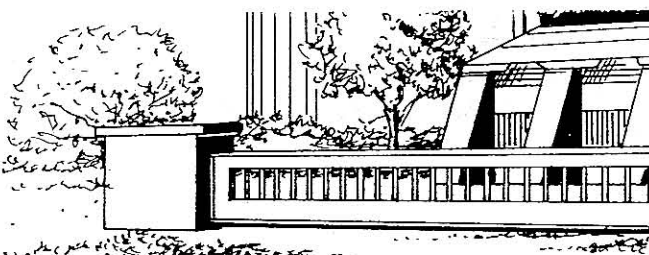

Visitors? No!

If a player character presents himself at the gate, he will be turned away by the guards after they consult an appointment list. If the player character presses the issue, he will be told that no exceptions are made, period! If he raises a fuss, the internal security guards will summon city security men to run the troublemaker off or arrest him if they think him persistent or dangerous.

Stakeout

The players may decide to stake out the place from the public park, but they may be spotted by the security guards at the gate unless they have made some effort to remain unobtrusive. Do not tell the players this, but make a secret Saving Roll against the watchers' average LUC score (add the LUC scores together and divide by the number of watchers), with a five-point penalty subtracted for every watcher more than two. If the player characters are trying to be inconspicuous, add a 20-point bonus to the score before making the Saving Roll. If the roll is successful, they will escape notice. If the roll is not, the security guards will notice them after a time (gamemaster choice) and call city security men to run them off.

The stakeout will give the player characters some information. Kaylo Delfi will return to the estate in his car, and this may return while they watch. If any of the player characters have thought to bring a telescope or field glasses, when the car returns, they will be able to see an Orion driver in front and a Vulcan male in back, both wearing standard Delfi orange uniforms. In the back there is also an Orion male dressed in upper-class clothing. If Kaylo Delfi's file has been accessed by the players, they will recognize him from his picture.

To determine if Kaylo leaves while the player characters are watching, roll 1D10 every half-hour they watch. (Remember random encounters in the meantime.) On a roll of 9 or 10, they will see a large ground car roll up and immediately pass through the gate. It will leave again two hours later, and only return late that evening.

Any character who gets a good look has a chance to notice Kaylo's drugged condition. Make a secret Skill Roll against the character's rating in *General Medicine*. A successful roll indicates that the watcher will notice that the upper-class Orion looks sort of pale and stiff, almost glassy-eyed.

Any attempt by the characters to interfere with the car's coming or going in any way will bring a swarm of guards from the estate, and they will come out shooting. The car is armored and proof against phaser fire short of a phaser disintegrate shot, which would disable it. The guards will set weapons to disrupt if the car is disabled. The occupants of the car will not come out, no matter what.

If the car is followed on its way out (assuming the characters have a ground car of their own), the player characters can follow it to the Delfi Corporation offices in the Financial Quarter. It will pass through a vehicle entrance, which will be sealed behind the car.

Nothing else of interest can be discovered at the Kaylo Delfi estate, and the gamemaster should try to keep the players from getting too far off track and spending too much time there.

TOORA DELFI'S ESTATE

The estate of Toora Delfi and his immediate family is not the opulent fortress owned by family leader Kaylo, but his security setup appears to be more than adequate. There is an eight-foot wall around the area, with a set of metal gates that seem to be controlled by a pair of guards in a small shack.

In this case, the gates are made of normal metal, easily destroyed by phaser fire; they *are* controlled from the guard

shack. (It is unlikely that reasonable players would wish to attack the gate, but one never knows.) There is no security field above the walls, but anyone climbing over or passing over in any way within 6 feet of the top of the wall will set off a silent alarm in the security room inside. It also will summon 1D10 guards, who will have their phaser II sidearms set for disrupt.

Unknown to the characters, the guards here, all personally loyal to their employer, are a bit jumpy because of an attempt last week to kidnap the young son of Toora Delfi. The attempt failed when the intruder was killed, but Toora felt it was a good idea to keep the matter quiet, since he no longer trusts the corporate-controlled city guards. In fact, Toora has had trader friends smuggle his immediate family off-planet for their own protection, while maintaining the

fiction that they are in seclusion at home. His guards are alert, expecting the trouble within the corporation to erupt into violent action. Thus, the guards are jumpy and will shoot first and ask questions later if anyone forcibly intrudes on the estate.

The player characters will have to use their skill in *Streetwise* to find an unobtrusive place to watch the building. If the gamemaster rules that a Skill Roll is necessary, only one may be made, no matter how many player characters are present.

If the player characters are able to set up a stakeout, they will observe that no vehicles or visitors will come and go all day. Wisely, Toora is not coming home at night, but stays at his office. Random encounter rolls should be made for each half-hour spent watching.



The OTHER Spy

An Orion has been sent by T'Lovus to watch Toora Delfi's estate. He wears conservative, grey-brown, middle-class dress and watches the estate from a hiding place that may be spotted by the player characters. For each half-hour the player characters spend watching, make a secret Saving Roll against the highest LUC score among the watchers. If this roll is successful, the watchers will discover they are not the only ones staking out the estate!

They will see the Orion observing the estate from hiding, making occasional notes in a notebook. If they watch long enough, they will see this Orion watch until dusk, when he will be replaced by another Orion. If either of these Orions is approached by the player characters, he will close his notebook quickly and walk away. If questioned, he will deny he is doing anything wrong. If he is followed or stopped, there will be an argument. He will insist on leaving unless physically detained.

The spy, who has the same statistics as an Orion guard, will fight, if necessary, to escape. He has a concealed knife that he will use (*To-Hit, Knife* - 55), but he will avoid this as long as possible.

Dealing With Toora's Guards

If violence erupts across the street, the guards from Toora's estate will call for reinforcements from other estate guards, but will not call the city guards. After 12 combat rounds, six guards will come over and break up the fight, if it is still continuing.

The guards will detain both the spy and the player characters only long enough to ascertain that they are no direct threat to the estate, unless the player characters accuse the Orion of spying. If so, the spy will make similar accusations against the player characters. The guard captain will listen to both sides. To judge the effects of this, make a Skill Roll against the ratings in *Negotiation/Diplomacy* for both the spy (Skill Rating 40) and for the player character spokesman.

If both rolls are successful or both are unsuccessful, the guard captain will not know whom to believe. He will release both the spy and the player characters, warning them to stay away from the estate.

If the player character's Skill Roll is the only successful one, the guard will take the spy into custody. He will ask the characters to give their names and to tell him where they may be contacted. He will not admit them to the estate, but will promise (if asked) to mention their cooperation to Toora Delfi.

If the spy's Skill Roll is the only successful one, he will be set free. The player characters will be interrogated for an hour before the captain eventually will realize he has nothing concrete against them. Then, because he can't turn them over to the city police anyway, he will let them go.

The Spy's Notebook

If a scuffle occurs at any time between the spy and the player characters, the spy may drop the touch-sensitive pad on which he has been making his notes, and this may be

recovered by one of the player characters without the spy's knowledge. To determine if this occurs, make a secret Saving Roll against the greatest LUC score of all the player characters present. If the roll succeeds, the spy will drop his notebook and not immediately notice it has fallen.

Roll randomly to determine which of the player characters will notice it first. If this player character picks it up or says anything about it before the spy is gone, the spy will be angry and will not leave without it, which likely will prolong the scuffle until the guards arrive from across the street. No matter what happens from this point, the player characters will not get to read what is on the notebook; the only way that they will gain this information is if they do nothing about the fallen notebook until after the spy has left or been taken away.

The notebook is a pocket-sized, touch-sensitive pad with an electronic stylus. Words and pictures written on it are stored electronically and can be recalled with a series of button-controlled commands. It is a common model made by a UFP manufacturer, and so it can be used easily by the player characters.

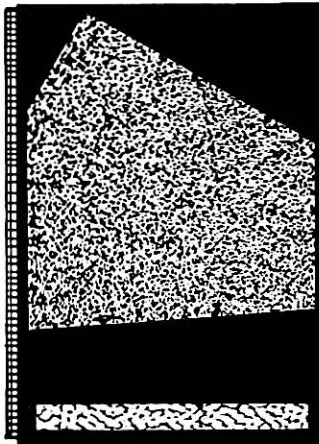

If they access the information, the player characters will discover the notation "Slagh Job" at the top of the first page, and below this the address of Toora Delfi's estate. They will find a list of times ten minutes apart on another page, with the notation "no action" next to each entry; this list ends at a time just before the time the spy was approached by the player characters.

RANDOM ENCOUNTERS

The gamemaster should roll for a random encounter every 15 minutes spent travelling in the area or for every four squares covered. A random encounter roll should be made even if the player characters are staking out either Delfi estate, but this should be made for every 30 minutes spent watching. Roll 1D10 and consult the table below.

Random Encounters In The Residential Quarter

Die Roll	Encounter Type
1 - 7	No Encounter
8 - 10	Delfi Corporation Guards

THE MERCHANTS' QUARTER

The Merchant's Quarter is the bustling main trade center for the spaceport and the city. Most brokerage companies, which buy trade goods and resell them at a profit to other

traders for transport elsewhere, maintain offices and warehouses in this section. Some companies handle only large bulk cargoes, whereas others are small lot specialists, dealing in quantities of 1000 SCUs or smaller. Some companies, the Delfi Corporation among them, have separate divisions for large and small lot cargo trading.

THE HIGH MARKET

The High Market is the center for most of the legal trading done on Bonus Run. Unlike the High Market of most Orion government-controlled worlds, this tradeworld's High Market is not restricted, and traders may buy and sell freely to whomever they choose. Brokerage offices for many firms are here, with their warehouses located elsewhere in the Merchants' Quarter. There are many smaller shops and open-air booths in the High Market as well. The place is noisy and alive with the cries of merchants selling their wares, beggars wanting handouts, children laughing and snatching fruit from carts, and so forth.

Shopping

If the player characters wish to shop around, they will find most any legal item for sale somewhere in the High Market. Merchants will ask about twice what an item is worth, but will usually settle for less. To determine the final price, the player should make a Skill Roll against his character's rating in *Negotiation/Diplomacy* or *Trade And Commerce*. If the roll is not successful, the price will be reduced no further than 20% more than normal, but if the roll is successful, the final price will be 10% less. Prices on items can be set by the gamemaster, or they may be taken from the lists in **Trader Captains and Merchant Princes**.

Out Of Business

As the player characters walk through the High Market, they will quickly notice that a number of offices are closed, particularly those of large interstellar trading companies and those of very small firms. Only medium-sized firms will appear to be still active. Local merchants and brokers will be happy to discuss the economic situation with the player characters. They will reveal that the large corporations are closing their local offices because they are becoming unprofitable, and the small firms are crumbling entirely because illegal cargo traffic is squeezing out the smaller legitimate operations. They will learn that most brokerages in the area are experiencing hard times.

Continued questioning may bring out the causes for this depressed state of affairs. The player whose character is acting as party spokesman should make a Skill Roll against his character's rating in *Negotiation/Diplomacy*. If the roll is successful, he will learn that every transaction on Bonus Run is influenced by the Delfi Corporation, which controls the spaceport, most of the cargo handling, and most of the banks and other financial institutions. The player characters would expect that this should be the case, because it is how tradeworld corporations make their money without charging import duties. They will learn that in this case, however, the Delfi Corporation has made some poor business decisions in recent months, and as a result, everyone's business is adversely affected. The player characters will find that the situation is a mystery to most of the local financiers and merchants, because the Delfi holdings have suffered as much as anyone's.

The player characters also will discover the important fact that the effects of the economic slump are felt beyond the planet itself. They will be told that most of the sector's free trade used to flow through this port, but now even the Orion Colonies, which chartered the Delfi group's development of this world, is considering declaring the planet a poor investment and abandoning their financial and military support. Locals will express their fear that this might create a

power vacuum, which could lead to Klingon or Romulan intervention to secure a foothold in the area.

DELFI SMALL LOT BROKERAGE OFFICE

The Delfi Small Lot Brokerage has offices in the High Market, but the small building which housed them is closed. A small sign has been attached to the front door which reads as follows:

HIGH MARKET OFFICES TEMPORARILY CLOSED

Please contact our warehouse directly.

Below this, the player characters will find an address not far away in the Merchant Quarter. If the episode described in **An Air of Murder** has not already occurred, nothing unusual will happen here at this time, and the player characters may visit the brokerage warehouse at the address given on the sign. If, however, the attack on the *Terri Bear* described in **An Air Of Murder** has already happened, there will be a special encounter here, as detailed in **Family Rivalry**.

DELFI SMALL LOT WAREHOUSE

The Delfi Small Lot Warehouse looks like a fortress, a heavy fence surrounding the place, with armed guards patrolling it. Any character with a Skill Rating greater than 20 in *Security Procedures* will note automatically that the protective measures seem to be fairly recent additions, not planned for when the complex was constructed, but no obvious weaknesses in the defenses will be visible.

Toora Delfi Not Met

This encounter at the warehouse gate depends on the events that have transpired. If the player characters have not met Toora Delfi, either because they avoided conflict with the toughs outside the Delfi Small Lot Brokerage offices in the High Market, or because they went directly to the warehouse without visiting the offices, they will be received as follows.

When the player characters approach the gate, the guards will ask them to describe in detail their business. If the characters claim they have cargo to sell, they will be told to bring it out for inspection. Unless they do come prepared with cargo to sell, a small card will be given to them which they are to present at the gate upon return with the cargo. If they bring the foodstuffs from the ship, they will be informed that the cargo is not saleable without proper health clearances at the port of origin, and the cargo will be turned down at the gate. If the characters ask to see Toora Delfi in person, the guard on duty will tell them that he is not available for personal interview at this time. He will offer to convey a message for the characters if they desire, however, and will promise to have someone from the brokerage call the next day at their ship's berth.

The purpose of this delay is to allow time for the incident described in **An Air of Murder** before the player characters actually meet Toora Delfi. If the player characters have been to the warehouse, in the morning after the attack on the *Terri Bear* a messenger will bring them the news that Toora will meet with them in early afternoon at the warehouse.

Other Circumstances

If the player characters have met Toora Delfi, or if the attack on the *Terri Bear* has already occurred, the reactions of the gate guard will be quite different. The guard will still offer to take a message, saying that Toora cannot be disturbed. If the message concerns Romulans, trouble within the Delfi family, or the player characters' concern about the economic situation, the guard will ask them to wait while he calls a superior and relays the message. After a few minutes, the player characters will be admitted to the complex and escorted by two guards to see Toora Delfi, and the events described in **Family Rivalry** will occur.

RANDOM ENCOUNTERS

On a tradeworld, the merchant's quarter rarely sleeps, and the activity there is only slightly lessened at night. The locals in this part of the city expect to see visitors of all types here. Roll for a random encounter every 15 minutes spent here or every 4 squares of travel on the way in and out of the area. Roll 1D10 and consult the table below.

Random Encounters In The Merchant's Quarter

Die Roll	Encounter Type
1 - 5	No Encounter
6 - 8	Street Dealer
9 - 10	Pickpocket Attempt

TRAP!

If the player characters come snooping around, halfheartedly searching for clues, the apothecary (drug dealer) Jaclan Uvane will, of course, immediately contact T'Lovus. Uvane also will contact T'Lovus if the player characters are trusting or careless enough to accept Uvane's word that he will set up a meeting; in this case, T'Lovus will give Uvane instructions to play along with the meeting.

T'Lovus, in either case, will send several hoodlums (employed by the Delfi Corporation) to get rid of the snoopers. Use the statistics for the Orion bar toughs in the **Cast Of Characters** section to represent the muscle he sends. One tough, armed with a phaser I, will be sent for each character who showed up in Uvane's place asking questions. Thus, if some of the characters didn't go in, the odds against them will be lessened.

AMBUSH!

If the player characters did not set up a meeting but merely snooped, the toughs will intercept them on the street. They will use their phasers to stun the player characters, if possible, taking the helpless victims captive as described in **Springing The Trap**, below.

If a meeting was arranged, the toughs will come straight to the apothecary shop, approaching through the alley at the rear. Only if the player characters have decided to stake out Uvane's shop and are watching both front and back will they see the group of husky Orions arrive and be warned to expect trouble. Several customers will go in and out of Uvane's place between the time the characters leave and they return for the meeting, but none could possibly be a Romulan in disguise. Uvane's young Orion assistant will be the only other person seen to leave Uvane's, and he will leave by the back door.

The thugs will enter through the back door, which the player characters will not know about unless they have searched Uvane's place thoroughly. They will wait in Uvane's concealed lab, which Uvane will have sanitized, concealing or destroying all traces of suspicious chemicals and notes.

A SIP OF BRANDY

When the crew returns for the meeting, Uvane will assure them that The Romulan has been summoned and will arrive shortly. He will offer to pour them some Saurian Brandy from a bottle he keeps behind the counter. Uvane will pour for everyone, including himself. He will try to get the characters to sip the brandy, which is drugged, even if he has to drink it himself.

The brandy is laced with a delayed-action, heavy sedative, potent enough to be effective even if the victim swallows only one sip. Five minutes after the brandy has been sipped, the drug will take effect, as detailed in the STRPG2 rules.

If the player characters refuse the brandy, or if Uvane thinks he is threatened in any way, he will yell for help. Characters may attempt to fake drinking the brandy, but Uvane will be watching for this. In order to do this successfully, a character must make a successful Saving Roll against his LUC score, and Uvane will have to make an unsuccessful Saving Roll against his INT score of 66. If either the character fails his Saving Roll or Uvane does not fail his, Uvane will notice and yell for the thugs in the back room, and the fight will be on. If all the characters are made helpless by the drug, no fight will be necessary and the encounter will proceed as described in **Interrogation**.

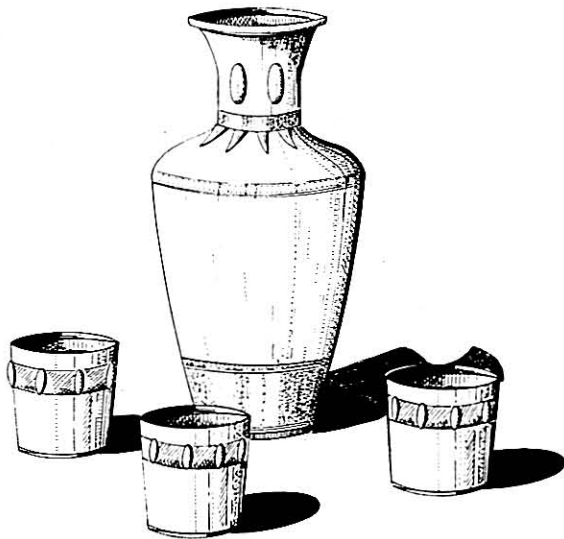

SPRINGING THE TRAP

In response to Uvane's call, the secret door into the back room will open and the Orion toughs will burst in, phasers drawn on a stun setting. They will use the counter as cover, if possible, and try to drop as many of the characters as they can, but they will not pursue characters into the street. Uvane will slip out through the back door, if he can, and escape unless a player character is watching the back and can stop him.

Outcomes Of The Fight

If all player characters are rendered unconscious, proceed as described in **Interrogation**. If any player characters escaped, the interrogation will be skipped, and the prisoners will simply be disposed of, as described in **Eliminating The Evidence**.

If more than half of the thugs are knocked out of the fight, however, the rest will try to escape. They will drag unconscious comrades along, if possible, but they will abandon obviously dead ones. If they see that they cannot rescue a comrade, they will abandon him as well. Any toughs left behind may be captured by the player characters and questioned, as detailed in **Taking Prisoners**.

If only one tough remains, and he cannot escape, he will pull a small round object the size of his fist (a grenade) from under his tunic and push a button on it, dropping it to the floor. He will then dive for cover, if possible, either behind the counter or out the door. At the end of the next round of combat, the device will explode, giving 4D10 points of wound damage to anyone in the room who is not completely behind hard cover (unless a character has managed to scoop it up and toss it outside or behind the counter). The grenade also will fill the room with smoke, allowing him to escape. Any unconscious toughs left in the room without cover will be killed by the blast. The explosion will start a small fire, attract-

ing a lot of attention. The characters should be encouraged not to hang around, and if they do, the crowd will become ugly.

TAKING PRISONERS

If any tough is taken prisoner and can be returned to consciousness, he will admit he works as a guard for the Delfi Corporation. If questioned directly about where he got his orders, he will say that he was sent out by Kaylo Delfi's personal bodyguard. If the player characters press the matter further, he will reveal that the bodyguard is a sullen Vulcan called Slagh. If the characters don't ask specific questions or dig for these details, don't give them out. The guards know nothing else of interest.

If the player characters take a prisoner along when they leave, or foolishly try to turn one over to the authorities, the tough will yell for help from the first corporate police officer he sees. Unless the player characters immediately dump their prisoner and run, their mission will be blown. The captured tough will identify himself as a corporation guard and accuse the player characters of shooting up a citizen's place of business and attacking company police. The characters will be arrested unless they shoot their way out, make it back to the ship, and escape from Bonus Run. If they allow themselves to be taken, they will cool their heels in a prison cell for a few weeks, not allowed to talk to anyone. After this time, they will be bailed out by a man identifying himself as a UFP official. He will rake them over the coals for causing an incident and blowing their mission, and have them returned home as fifth-class passengers on an ore freighter. They will never hear from Salak again.

INTERROGATION

Unconscious or incapacitated player characters will be dragged into the back room by the toughs. Uvane will check each to be sure they are actually unconscious. Any who are found to be still conscious will be injected with a second dose of the drug, which might well kill them, as discussed in the STRPG2 rules. Allow each character who is drugged into helplessness but not actually unconscious to attempt a Saving Roll against his LUC score. Success means that Uvane thinks the character is completely out of it. Actually, they can see and hear some of what is happening, though they cannot move.

One prisoner will be singled out for interrogation. The toughs will pick the leader, if one is obvious, or another at random. The players will be aware of what is happening only if one or more is conscious. The victim will then be given a truth drug that will put him into a trance-like state, aware of his surroundings and receptive to suggestion. The tough will then ask the character a series of questions.

For each question, the victim may attempt to resist answering at all, withhold information not actually asked for, or give incomplete data. The player may make a Saving Roll against his character's MAX OP END score. If the roll is successful, the victim may resist in some way, depending on the roll (gamemaster's discretion); if he answers at all, he *MUST* tell the truth. If the roll is unsuccessful, the victim must answer the question truthfully and completely. If the victim fails to answer, the thug may ask a second time, requiring a second Saving Roll. If he gets no answer to three questions in a row, he will give up. One thug will want to try with someone else, but it will be pointed out that there is no time.

The questions will be asked in the order below.

- 1) What is your name?
- 2) What ship are you from?
- 3) Who sent you here? (An answer of "Cevlac Loban" is truthful and acceptable, if the character decides to say that.)
- 4) Why are you looking for a Romulan?

Terri Bear, Mission Class II Small Commercial Transport

Top Deck

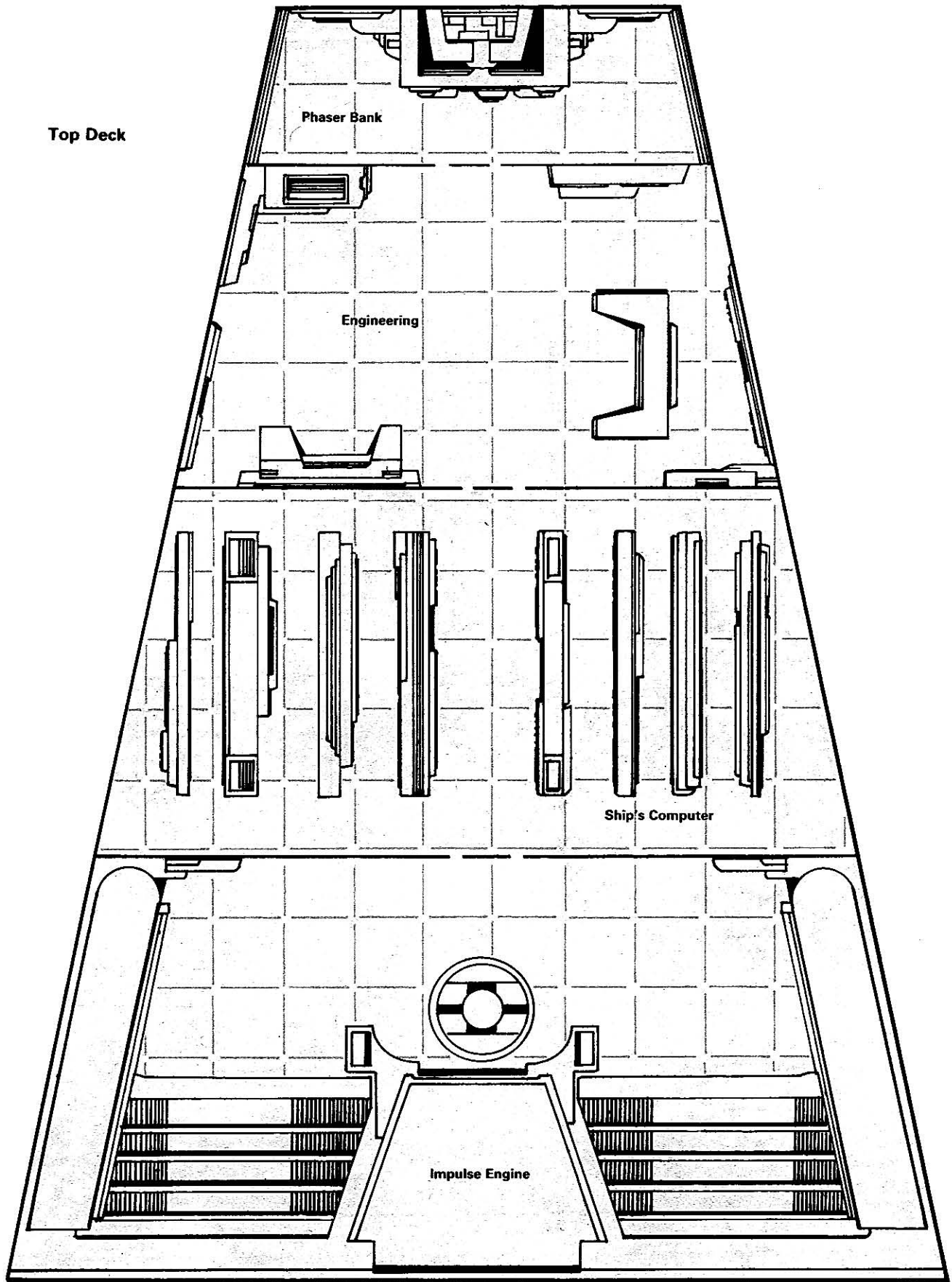

Remove this page.

1 square = 1.5 meters

Terri Bear, Mission Class II Small Commercial Transport

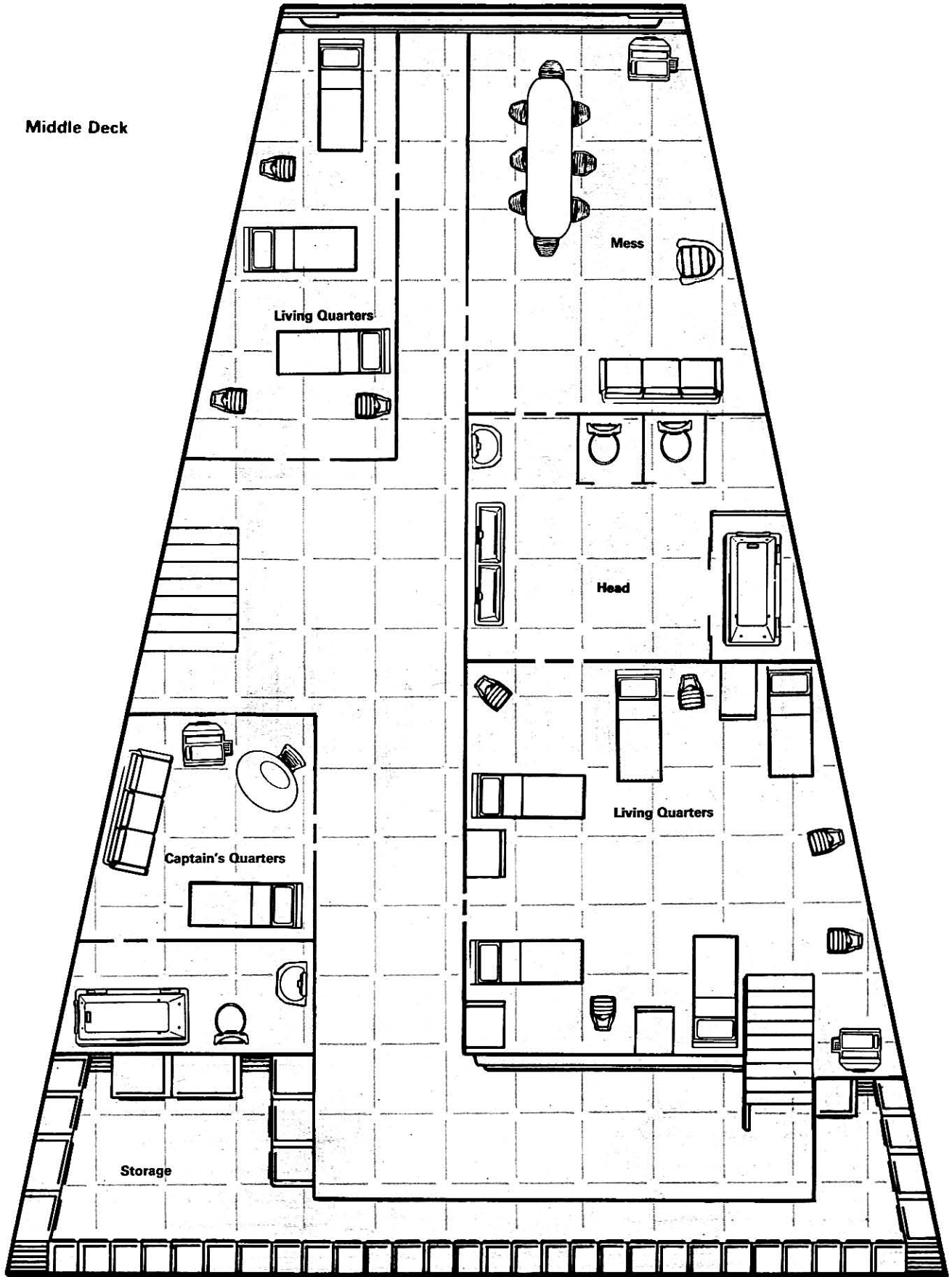

Terri Bear, Mission Class II Small Commercial Transport

Lower Deck

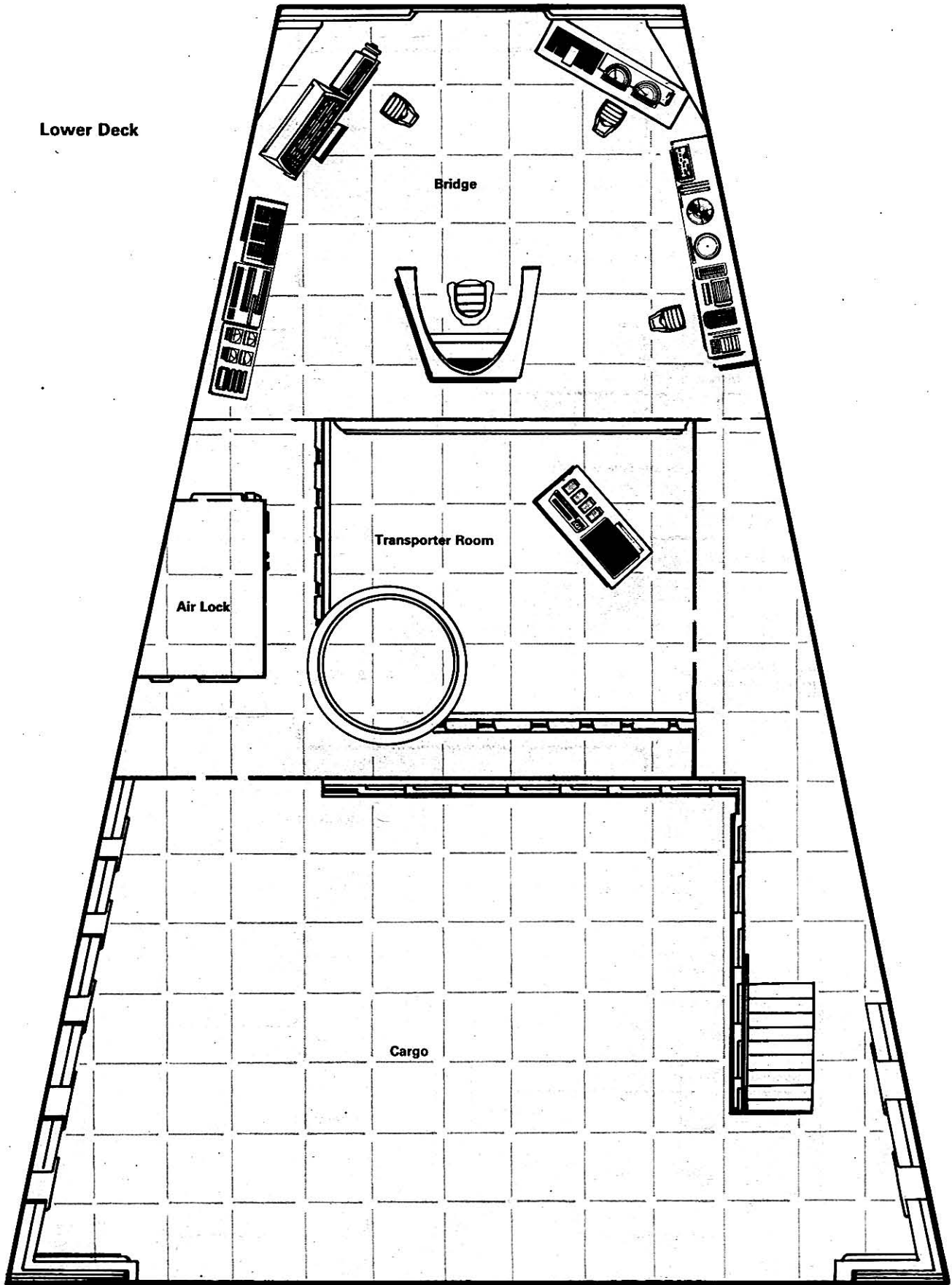

Remove this page.

1 square = 1.5 meters

GAMEMASTER'S MAP

BONUS RUN CENTER

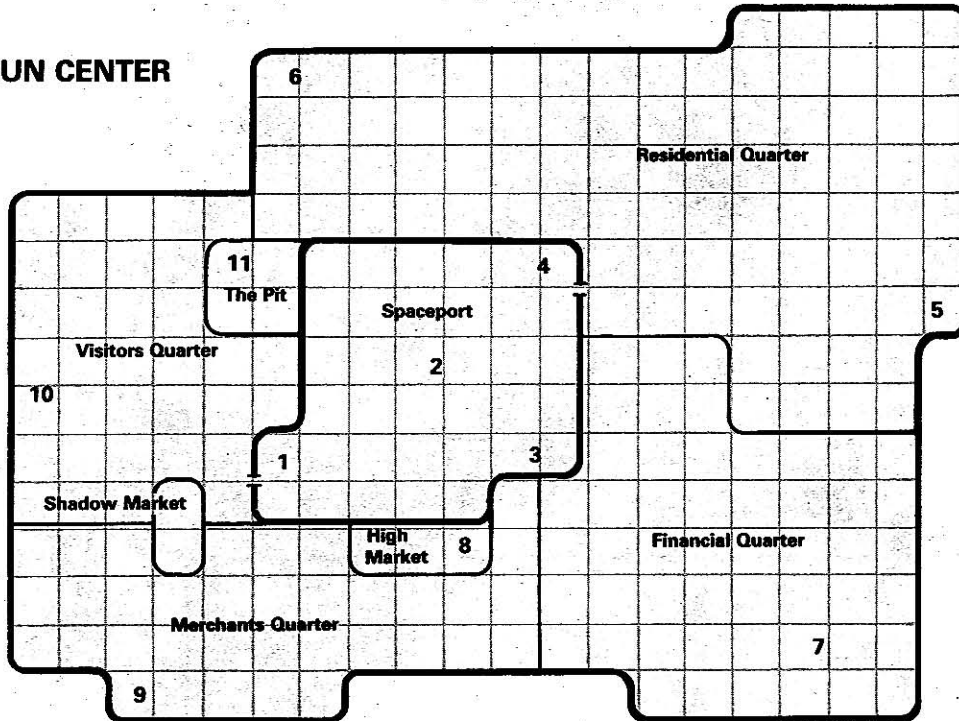

- 1 - Main spaceport buildings and main gate
- 2 - Landing field
- 3 - Berthing area
- 4 - North Gate
- 5 - Keylo Delfi estate
- 6 - Toora Delfi estate
- 7 - Delfi Corporation Offices
- 8 - Delfi Small Lot Brokerage Office
- 9 - Delfi Small Lot Brokerage Warehouse
- 10 - Loban trade advisors
- 11 - Loban warehouse
- 12 - Apothecary shop

PLAYER'S MAP

BONUS RUN CENTER

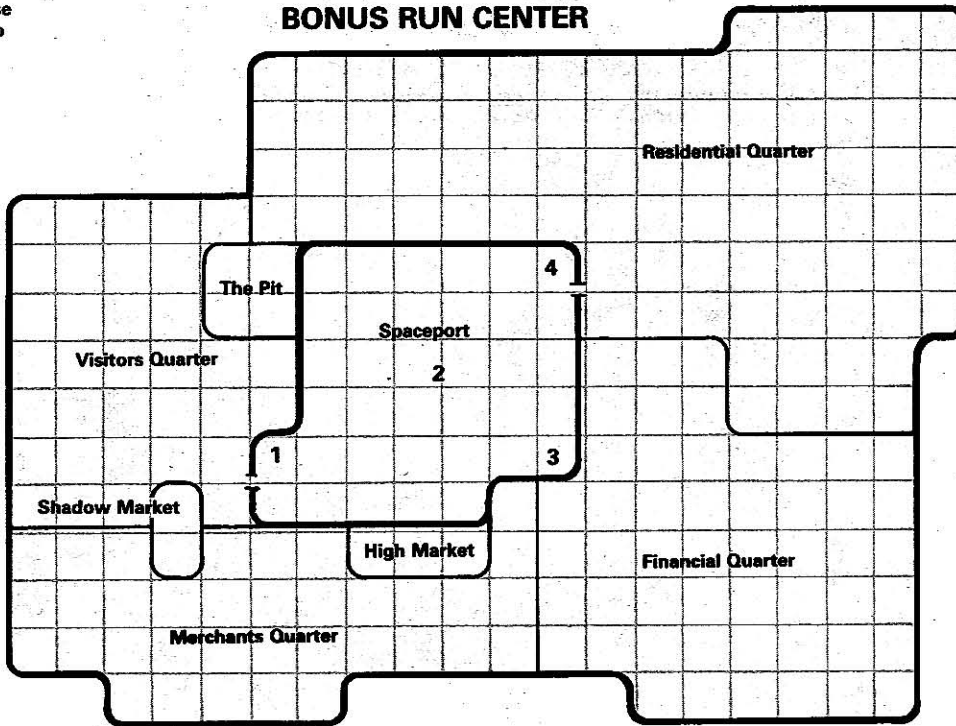

- 1 - Main spaceport buildings and main gate
- 2 - Landing field
- 3 - Berthing area
- 4 - Keylo Delfi estate

Remove this page.



1 square = 4 city blocks
5 minutes walking / 2 minutes driving

LOBAN TRADE ADVISORS

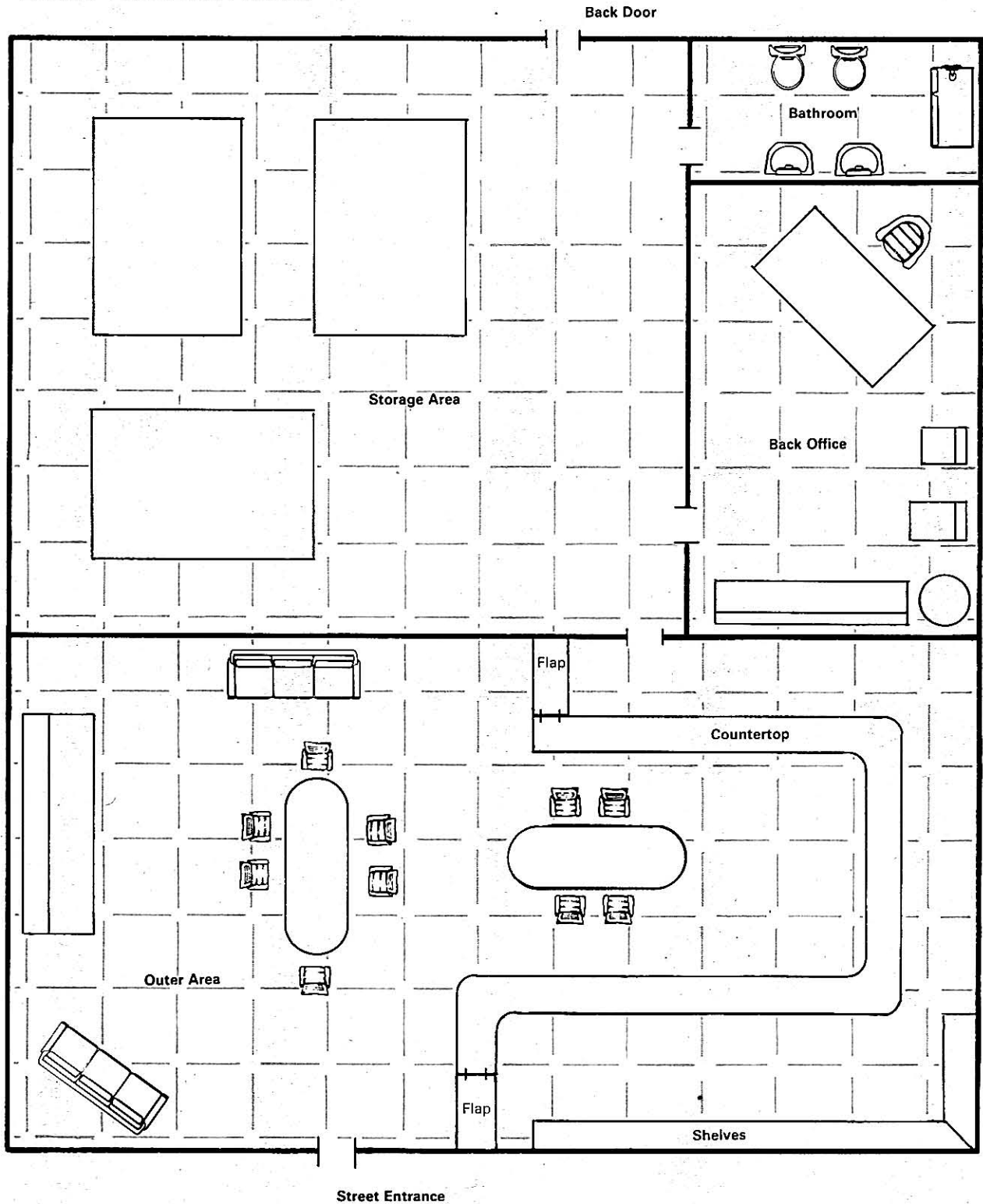

1 square = 1.5 meters

Remove this page.

APOTHECARY SHOP

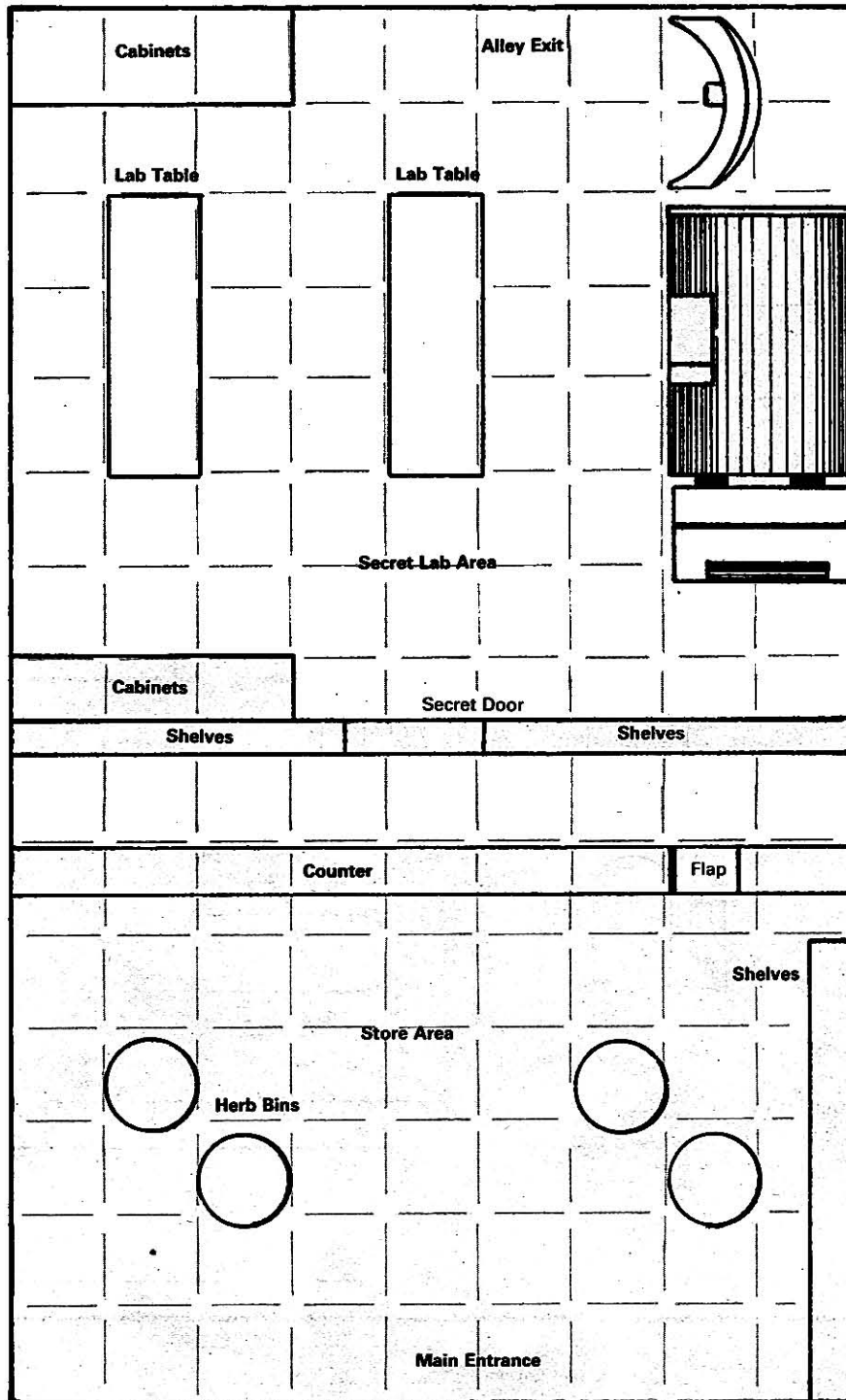

1 square = 1.5 meters

Remove this page.

DELFI CORPORATION PRIVATE OFFICE

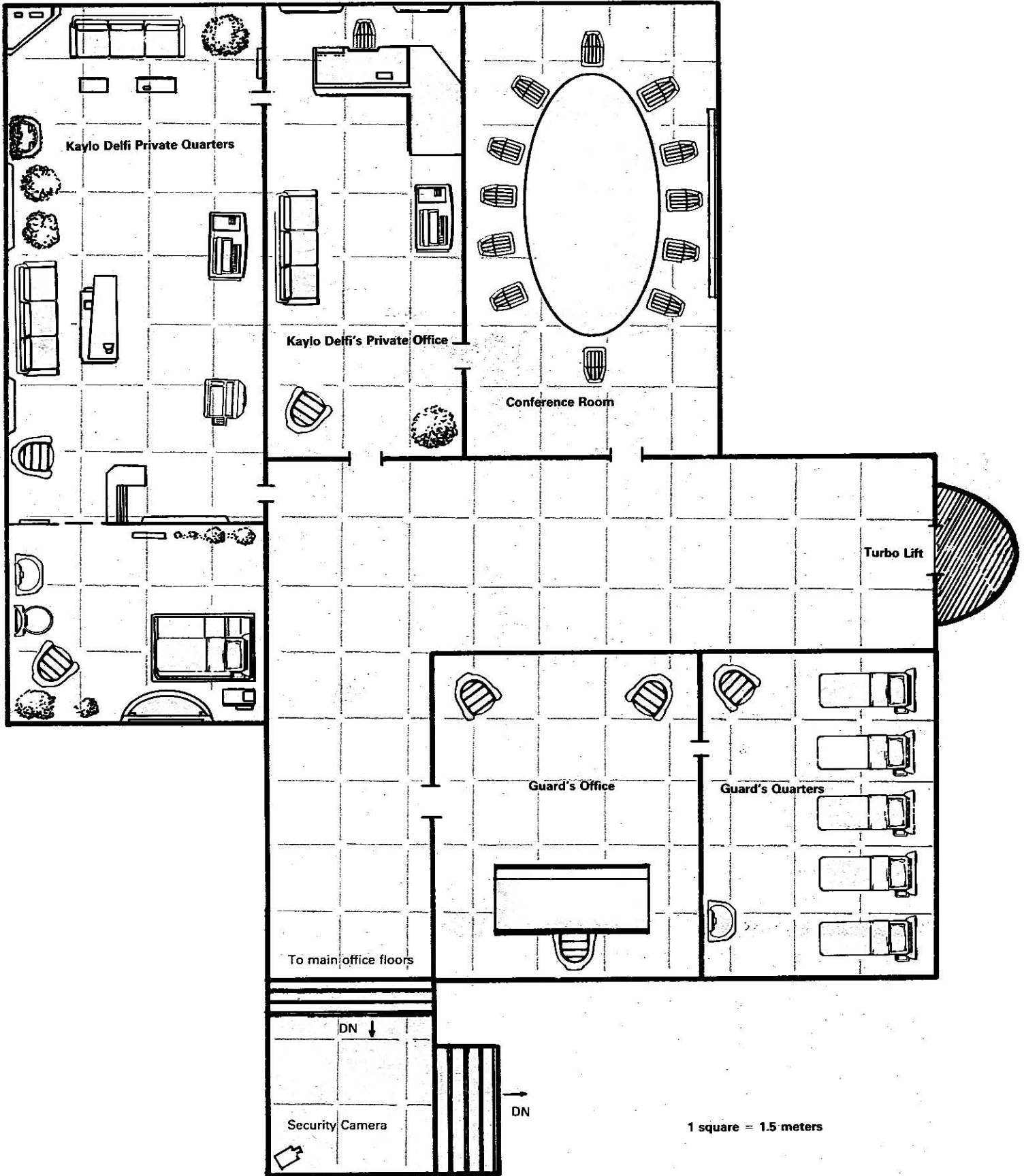

Vessels

TERRI BEAR, Mission Class II Small Commercial Transport

Hull Data:

Numbers — 61000-61399
Model Numbers — MK I
Date Entering Service — 1/9101
Number Constructed — 306

Size

Length — 32 m
Width — 25 m
Height — 13 m
Weight — 9000 mt
Cargo Units — 100 SCU

Other Data:

Crew — 9
Transporters —
1 standard 3-person
1 cargo

Engines And Power Data:

Total Power Units Available — 14
Movement Point Ratio — 3/2
Warp Engine Type — FWA-1
Number — 2
Power Units Available — 6
Stress Charts — G/K
Maximum Safe Cruising Speed — Warp 7
Emergency Speed — Warp 9
Impulse Engine Type — FIA
Power Units Available — 2

Weapons And Firing Data:

Beam Weapon Type — FH-6
Number — 1
Firing Arcs — port/fwd/stbd
Firing Chart — N
Power Range — 0 - 3
Damage Modifiers — +2(1-7) +1(8-13)

Shields And Damage Control Data:

Superstructure Points — 2
Damage Chart — B
Deflector Shield Type — FSC
Shield Point Ratio — 1/1
Maximum Shield Power — 12

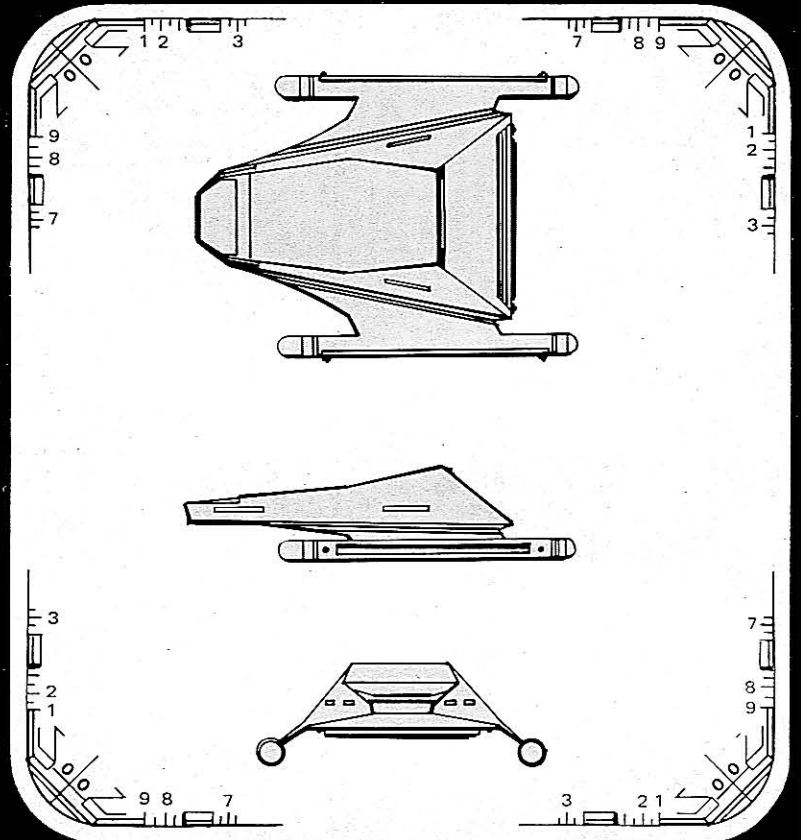

Greetings old comrade!

I trust that this message finds you well and that your career is going smoothly. It has been a long time since we were in contact, but, as you know all too well, space is vast and distances are long. Sometimes, trying to maintain relationships while serving in Star Fleet tests even Vulcan patience.

I have been pursuing my duties here at Starbase 7 for several months, and I find my work as Sector Chief Of Scientific Operations challenging and rewarding.

I am still not used to being addressed as Commodore. Though I am out of the usual chain of command, I find it strangely unsettling to be suddenly senior to many of the officers with whom I served in the past. Some of my fellow Vulcan officers warned me that my Human comrades might react to my promotion with resentment, but this does not seem to be the case. I have been around Humans long enough to recognize such emotions, though I do not pretend to understand them. Most of my old companions have expressed pleasure at my elevation in rank, however. Of course, I know quite well how you felt about the matter. Your expression of feeling at the going-away party you threw for me when I was reassigned was quite unmistakable. The light-sculpture of my old ship that you gave me on that occasion adorns my desk even now (I have suppressed the extra circuit), and the memories of our talks together are very important to me.

It is difficult for me to presume upon an old comrade by asking for a favor, but circumstances require I do so. Much of what I ask herein I cannot explain, but I know I can trust you to help me at this time. Much depends on this, my comrade – more than either of us knows. I am sure.

You will be contacted sometime in the next two days by a Vulcan named Salak, who will identify himself by telling you the result of our final chess game. Salak is on a mission of utmost importance to the Federation, and one that must remain absolutely secret.

Choose a few of your best fellow officers and meet with Salak. When you have heard what he has to say, I urge you to aid him with his mission. I will pull whatever strings I must at this end to free you and those you choose to aid Salak in whatever way he desires. Such manipulations of schedule must be done quietly, and so I have avoided the usual Star Fleet channels in delivering this message. You must not discuss this communication, Salak's mission, or your part in this with anyone who is not to take part with you in the mission itself. You will have no official Star Fleet sanction, and so you must rely on those personally loyal to you. If I know you, there will be many such persons serving with you.

Do not attempt to contact me until the mission is completed. I cannot respond, and would be forced to deny all if approached publicly. I know this is irregular, but the circumstances are irregular as well. I can only rely on a Human quality that I have admired but never understood – trust. (We Vulcans trust what we observe and can verify, but Humans trust in intangibles such as personal loyalty and friendship. Of course, these things cannot be part of my psychological makeup, but I have observed them and I count on them now.)

For whatever it is worth, I wish you the luck that you Humans seem to put so much faith in. If "luck" exists, may it favor you and this mission.

Sonam

Terms have been agreed to, as per our conversation. Both groups will cooperate, or at least will not hinder. Arrangements have been made to get you Federation helpers, not of our organization, to avoid suspicion. Obviously, you must remain hidden or your quarry will run. Even this communication is unsafe, but perhaps in this language it will be more secure than in mine.

I do not agree with what you must do, but I know why you are doing it and why our leaders feel it must be done in this manner. I have learned to respect you. I wish you success in restoring what you lost. If anyone can help you, the persons I have sent you can.

Someday, when all this is over once and for all, may we meet again under better circumstances.

Sonam

My Friend,

It is tragic that your connections with Salak went so poorly. I do not know what happened, but I know you must have had your reasons for not following him. Know now that Salak is dead, and I must again turn to you for help.

Salak the Vulcan was actually a Romulan outcast once named T'Slak, a highly-placed officer with their fleet before his fall. Circumstances made it necessary for the Romulan government and our own Federation to cooperate, though neither government could do so openly. T'Slak hoped to regain his lost honor by finding and assassinating another outcast named T'Lovus. This renegade is a dangerous extremist, who apparently intends to find a way to spark a war in this sector.

We do not know of T'Lovus' exact location, though he is known to be on Bonus Run. Nor do we know how he intends to accomplish his goals. We know of his plans only because T'Slak managed to leave behind notes made before his death. The only hope we have of containing the situation is to smuggle in a group of agents disguised as independent traders. Our own agents in Star Fleet intelligence may be compromised, and so we must look for volunteers.

I have disobeyed orders to tell you as much as I have, and I will surely lose my commission because of it, but it will be worth the price if war can be averted. These agents will aid you, but they cannot accompany you on this journey. Take only those you can absolutely trust. Jump ship if you must. But do what you can to end this threat. I will do all I can to cover your absence. I cannot stress enough that this is important to the peace of the galaxy.

Good luck to you, and may T'Slak's warrior soul find peace in whatever place his gods have prepared for him. In this life, he gave all he had to attain that peace, and failed.

Sonam out.

Permission granted to photocopy this page for personal use only.

- 5) Are there any Romulans with you? (If the character knows Salak is a Romulan posing as a Vulcan, he must answer "Yes.")
- 6) Are you working for Star Fleet? (Star Fleet characters must answer "Yes". Independent traders aren't sure.)
- 7) Are you working for the Romulan Star Empire? (The answer, as far as the characters should know, is "No.")
- 8) Does anyone know where you are? (Depends on whether Salak has been kept informed.)
- 9) Do you work for Toora Delfi? ("No", in any case.)

If no character except the one under interrogation is conscious, only the player whose character is being questioned should be present when the gamemaster asks these questions. After the questioning is finished, the player should then be told he is given a post-hypnotic suggestion to forget the questioning. This means that the player may not tell the other players what happened, discuss it, or even hint about it. The memory block could be removed by Vulcan mind meld, but the characters will not get Salak to agree to perform one (because he cannot, though they don't know this). A player character Vulcan could try, however, if made aware of the problem in some manner.

ELIMINATING THE EVIDENCE

Once the interrogation is over, or if the interrogation must be skipped because a player character escaped, the thugs will pick up their fallen comrades (including the bodies of those who might have been killed) and leave by the front door. One will remain long enough to set a fire in the back room, however. If any player character is conscious, he will regain enough of his faculties to drag his companions out of the burning building in time to save their lives. If no character is conscious, the one with the highest LUC score will wake up in time, unless an escaped character returns to rescue them. Uvane will drop out of sight and never return to the place, nor will there be any clues left in the building.

AN AIR OF MURDER

On the first or second night the player characters spend in port, after they have been making inquiries and roused the suspicions of T'Lovus, the renegade Romulan will send some of his thugs to attack their ship. The thugs will attempt to panic the player characters into leaving their ship, whereupon snipers will pick them off. The plan is as follows.

Three thugs will approach the *Terri Bear* carrying a gas grenade, which they will attach to the hull over the main ventilation grid. Two more thugs equipped with phasers are hidden at some distance from the ship, with a clear field of fire at the airlock door. If there is a guard, the thugs will attempt to subdue the guard before the grenade is placed on the ship. When it is set off, the grenade will fill the ship with harmless green gas, a ploy to get the player characters to open the airlock in panic and confusion. Then, with the airlock open, the snipers can pick off any who exit.

Exactly what occurs will depend on the security measures the player characters have taken. Salak will have left this up to them. If they happen to think of it, that is fine. He will not suggest it.

TWO GUARDS ON WATCH

If two or more guards have been placed on night watch *outside* the ship, nothing will happen. T'Lovus' thugs will spot the guards and leave. If the gamemaster desires, one of the guards can hear the approach of the intruders, but no significant encounter is expected.

ONE GUARD ON WATCH

If only one guard was placed, he will hear a noise in the

darkness from beyond some landing field maintenance machinery, just beyond the range of any light source he has rigged up or carries. If he investigates alone, he will walk into a trap. Give the guard a Saving Roll against his LUC score to hear a noise behind him as he circles the obstruction. If the roll is successful and he turns around *immediately*, he will see a figure moving in the darkness. If the guard does not fire immediately, the next thing he sees will be a flash of blue light as a phaser beam is fired at him.

If the guard gets off a shot, resolve combat as if he were firing at medium range at a non-moving target. Apply a concealment modifier of -30 for the darkness. If a hit is scored, the character will hear a groan. Several wild shots will come from the area fired at, pinning the guard down for a moment. When he is able to follow, the intruders will be gone.

If the guard does not get a chance to shoot, resolve the shooting attempt for the intruder. Assume the intruder has an unmodified To-Hit Number of 70 and is firing a phaser I at medium range at a non-moving target. If the character is carrying a light source, there is no modifier for the darkness, as the light pinpoints his location. If not, grant the same -30 modifier the intruder enjoyed above as the target. If hit, the guard takes damage from a phaser I heavy stun effect. If this doesn't knock him unconscious, he may return fire and drive off the attackers, as above.

If the guard is unconscious, the intruders' plan will proceed as though there were no guards. He will be knifed, taking 2D10 points of wound damage in addition to his stun damage. Before anyone can get to him, he will take an additional 2D10 points of wound damage from blood loss. Nevertheless, even if he has been critically wounded, he can be rushed to the port hospital and his life can be saved, though he is likely out of it for this adventure.

NO OUTSIDE GUARDS

If there is no outside guard, or the guard is rendered unconscious before he can warn his shipmates, the first evidence the characters inside will have of a problem is a slight clanging noise, as the grenade is fitted to the hull. This will wake the character with the highest LUC score who is sleeping in the bunkroom, and it will be heard by any persons on watch inside the ship. Seconds later, a green gas will begin seeping into all compartments of the ship through the ship's ventilation system.

Each awake player character who sees the green gas and has skill in *Life Support Systems Technology* has a chance to remember that, though the ship circulates air from outside while in port, any harmful chemicals introduced would automatically set off an alarm through the ship's security program. A successful secret Skill Roll will give the player this information, and a check of the security panel on the bridge will reveal that this system is operating properly. In addition, the exterior air intake can be shut off either from the bridge or the engineering area, if the characters think to do so (make secret Skill Rolls against ratings in *Life Support Systems Technology* or *Astronautics*). Tricorders will reveal that the gas is harmless, but environmental suits are available for the whole crew in the ship's storage area, should characters want them.

SNIPER FIRE

The gas has been introduced as a ploy to get the characters to evacuate the ship in an unthinking panic. If the outer airlock door is opened and characters show themselves, a hidden sniper will open fire with a phaser rifle on the character with the lowest LUC score. Treat the attack as an aimed shot at a non-moving target from long range with a disrupt setting. The sniper cannot be seen, but his beam can be spotted, giving away his approximate location. If characters in the airlock wish to return fire, treat the target sniper as being a non-moving target about 80 meters away; his posi-

tion atop a nearby building will give him a concealment modifier of -40. The sniper will exchange shots with the characters until hit, then he will be dragged away by other intruders.

LIFT-OFF

Salak will awaken and come out unsummoned if the characters make a lot of noise, or if the sniper shoots someone. He will counsel against going outside and will insist everyone return to the ship. He will grimly make his way to the bridge, ignore all questions and interference from the crew, turn on the ship's landing lights, and prepare to lift the ship on its auxiliary chemical thrusters. Only if he is informed by the characters that one of their own people is still outside or if he is physically restrained, will Salak be dissuaded from lifting the ship. If a guard was left outside, do not remind the players or allow the player whose character is outside to remind those inside of this fact. They must think of it on their own.

If Salak is allowed to use the controls, smoke and flame will wash over anything within 100 meters of the ship, as he takes the ship straight up 100 meters and then lands it again. Of course, any intruders will be killed by the smoke and flame of the emergency thrusters, leaving a few blackened and unrecognizable bodies. If Salak is not allowed to move the ship, the intruders will still be scared off by the landing lights.

If a player character guard was outside, stunned or not, when the ship lifted off, the player should make a Saving Roll against his LUC score. If the roll is successful, he will be outside the area of destruction caused by the ship's thrusters. If the Saving Roll is unsuccessful, the character either will be burned to death, or (at the gamemaster's option) be given near-death injuries that will leave the character with some sort of permanent handicap, which the gamemaster can specify (facial burns which reject skin regeneration, a damaged limb requiring bionic replacement, and so forth). If the gamemaster feels this is too grim for the tone of the campaign, simply assume from the outset that the character was only stunned into unconsciousness and left outside the area of total destruction. He should still receive 2D10 of burn damage, however, if simply to remind the players to think about the consequences of hasty actions.

THE CAVALRY TO THE RESCUE

The lift-off and/or landing lights will attract the port police, who will move toward the ship in groundcars with flashing lights and sirens. Salak will order the crew to meet with the soon-to-arrive port officials, and report that the ship was attacked by armed men. He will instruct them not to report his presence on board, to claim no reason for the attack other than a possible hijack attempt, and not to make trouble with port authorities under any circumstances. He will assure them that he can straighten everything out later with a few well-placed bribes. He will return to his cabin, leaving them to meet the port authorities.

There will be no time to discuss the matter, as port police and fire vehicles will already be arriving. If the characters stick to the hijacking story, they will have little trouble with the port authorities. Fortunately, a number of witnesses saw the exchange of gunfire or saw people sneaking around the ship. The canister of harmless green gas will be found clamped to the ship's exterior air intake.

The authorities will be annoyed at the extreme defense measures taken by the crew, but will be more concerned with who is going to pay for any damage than the fact that several dead intruders now litter the landscape. The player

characters will be warned not to lift ship until a hearing can be scheduled and convened. They will be told that an extra guard will be put on their corner of the port, and they are to inform the authorities if they intend to travel farther away than the city. The gamemaster should make every attempt to have the players feel that, for once, the loose nature of tradeworld law is working in their favor.

FAMILY RIVALRY

BRAWLING IN THE STREET

Just as the player characters finish reading the sign, a burly Orion dressed in gray will come up and abruptly rip the sign from the door. He will glare at the player characters and walk away with the sign. If the player characters acknowledge him in any way, he will become belligerent, for his purpose is to drag them into a street fight. As soon as he has half a reason to fight, he will whistle loudly. A group of Orion bar-toughs, in numbers equal to the size of the player character group, will appear from around the corner. Most are dressed in greys and browns, but one wears an orange jumpsuit, with a few scraps of stitching where a round insignia has been removed recently. Though all the toughs are wearing holstered Mark I disruptors, a common Orion sidearm, none will draw his weapon, however, unless the player characters do so.

The Orion group will tell the player characters to leave the High Market "if they want to stay healthy." If the player characters refuse, the first Orion will throw a punch at the player character with the lowest STR score, and a fight will begin. The Orions will brawl with the players in the open square in front of the Delfi Brokerage building until more than half of the Orions are unconscious, or someone is killed on either side. Then the remaining Orions will run away and soon lose themselves in the High Market, familiar territory to them. There will be many onlookers, including two city security officers dressed in Delfi orange uniforms, but they will not interfere. (If too much attention is paid to them, the security officers will slip away.)

MEETING TOORA DELFI AT LAST

If the player characters lose the combat, when only one player character is left conscious, the fight will be broken up by the arrival of six Orion guards. The guards also will arrive to witness the end of the combat if the player characters win. In either case, the guards, armed with Phaser II in holsters and stunclubs in hand, will be escorting a middle-aged Orion in upper-class clothing (Toora Delfi). Both the guards and the man they are escorting will be wearing Delfi orange, but their right sleeves are bright green. The Orion VIP's sleeves are covered with intricate embroidery in what appears to be real gold thread, and he wears a gold amulet emblazoned with the Delfi family crest. The guards will take custody of any stray Orion attackers left behind.

Two guards will stay with the middle-aged Orion at all times, stunclubs drawn and ready, while he questions the player characters about the fight. If given a reasonable account of the incident, the Orion VIP will not seem surprised. He will introduce himself as Toora Delfi, the man in charge of the Delfi Small Lot Brokerage, and he will apologize for the trouble the characters faced at his doorstep. He will order one of the guards to clean up the mess, replace the sign, and remain on guard to see it isn't torn down again.

A TRIP TO THE WAREHOUSE

Then, if the player characters have identified themselves as traders or explained that they came here hoping to speak with him, Toora will invite them to accompany him back to the warehouse. Surrounded by guards, Toora and the player characters will walk down the block a way to where several armored ground cars are parked. Toora will explain that he never travels without a guard escort these days, and he will invite the group to find seats in the back of the cars for the trip to the warehouse. Toora's own car can hold two people besides his driver and his two personal guards, who will not leave him. Any other characters along can divide themselves equally between the other two vehicles and ride with the remaining guards and drivers.

The trip back to the warehouse will be uneventful. As the ground cars approach the building, which looks like a fortress, the player characters will see that a heavy fence surrounds the place, with armed guards patrolling it. Any character with a Skill Rating greater than 20 in *Security Procedures* will note automatically that the protective measures seem to be fairly recent additions, not planned for when the complex was constructed, but no obvious weaknesses in the defenses will be visible.

The guards at the gate will admit the groundcars only after they have stopped the caravan and looked in the back of Toora's vehicle, receiving his personal OK. The groundcars will then pull around to the front of the building. Toora and his personal guards will then escort the player characters to Toora's private office, where the events detailed in **Conference Time** will occur.

CONFERENCE TIME

The player characters will find the office of Toora Delfi to be well-furnished, but not the overly elaborate affair many Orion businessmen keep. Once all his visitors are comfortably seated and his personal guards are stationed at either side of his desk, Toora will begin introductions all around.

If the *Terri Bear* is mentioned, Toora will reveal that he knows about the trouble at the spaceport. He will tell the player characters that he suspects that they and his own small branch of the Delfi family may have the same set of enemies – mainly the leading faction of the Delfi clan headed by Kaylo Delfi. He will suggest they share information. If the player characters agree, Toora will fill them in on some family history.

In this conversation, Toora will reveal his bitterness that Kaylo's part of the family gained control of the firm years ago at the expense of Toora and his relatives. He will reveal that he has long wanted to regain the family corporation's leadership, but recently the conflict has escalated from a family squabble to what may become full-scale war.

He will tell the player characters that he has been left only with the leadership of this one small branch of the Delfi holdings. Of late, Toora will say, it seems Kaylo is not even content to let him keep even that small amount of control, and the larger branches of the firm have undermined his operations. Even so, he will say that enough family members are displeased with the recent fortunes of the family firm that Kaylo has been unable to ease him out of the company completely. Toora will say that he had been sure that the company's recent financial woes, brought about by Kaylo's

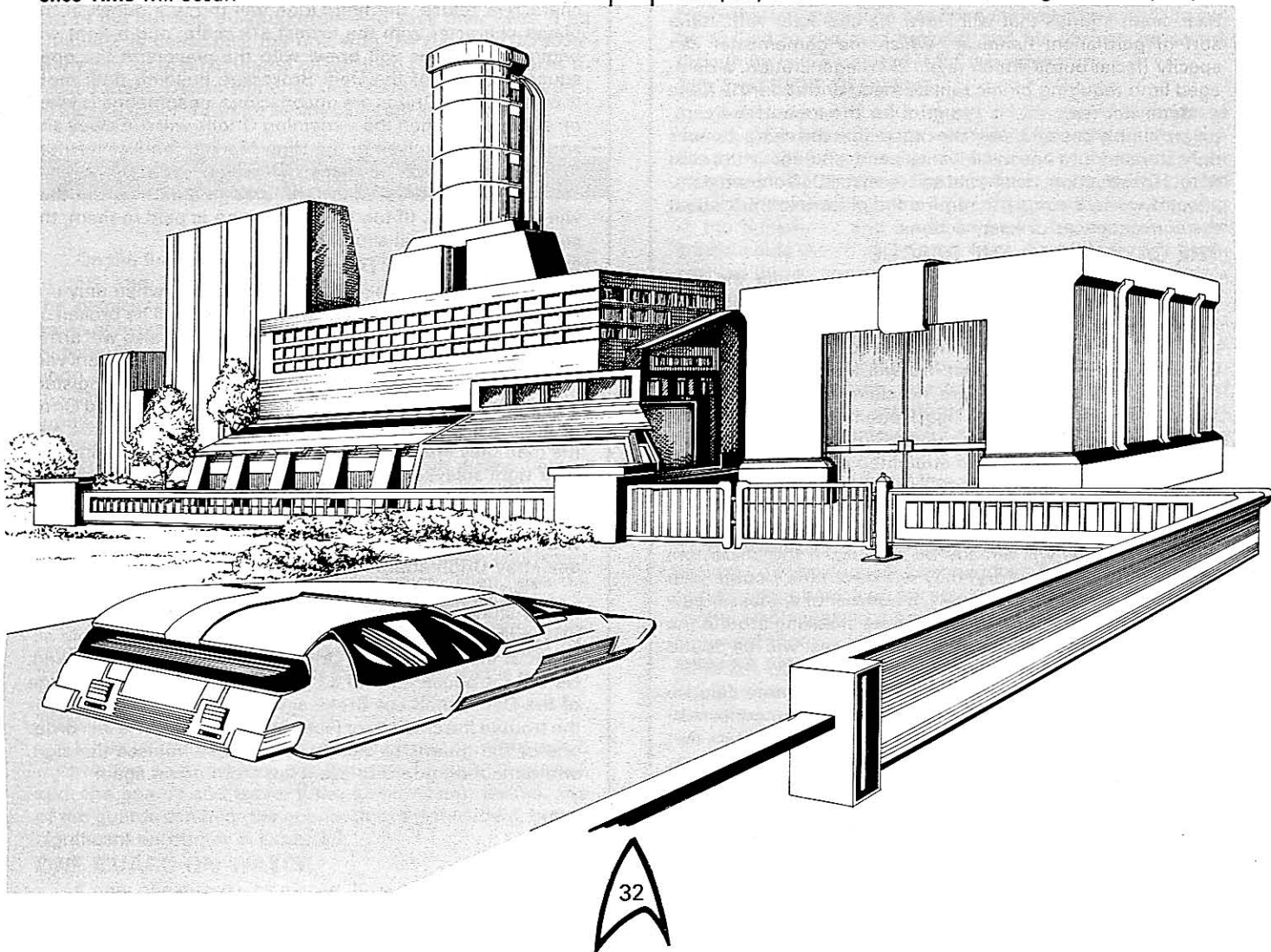

poor decisions, would have undermined Kaylo's support, but the board remained firmly on Kaylo's side in all matters, even voting to suspend regular board meetings until further notice. What is most distressing in Toora's eyes is that Kaylo himself did not attend that board meeting, nor has he for some time. He has become a "paranoid recluse", as Toora will put it, seeing no one but his personal bodyguard and a handful of key company men. Toora will say that even he cannot get in to see Kaylo.

Recently, as Toora will explain, things have gotten ugly enough that he has had to have his immediate family secretly moved off-planet by trader friends, because he is no longer sure the city, even his own estate, is safe. If the characters have been to Toora's estate, they will discover at this time that Toora knows about the incident. He will tell them that he is now sure the intruder was one of Kaylo's paid spies.

Toora will tell the player characters he is not sure what Kaylo hopes to gain. He will say that the planetary economy may be buckling, though it will not show to the average citizen for some time. He will relay his fear that economic chaos in this sector will stir up trouble with the Klingons, Romulans, and Federation, and that the Orion government will not interfere because Bonus Run has begun to be a burden, not an asset.

How much the player group wishes to reveal to Toora is up to them. Toora is a practical businessman, and really isn't interested in the workings of politics. He knows nothing about any Romulan connected with Kaylo's operations, but if he is asked, he will suggest that the only way to find out is to corner Kaylo himself. If questioned about Kaylo's personal bodyguard, Toora will say only that he is a Vulcan named Slagh, and that Kaylo never goes anywhere without him.

Toora will confide that he has one ace in the hole left – a highly-placed security man in the main office complex, who has been feeding Toora information. Toora will relay hopes that he can find out what Kaylo's plans are by planting a bugging device in the company's top security conference room, one of the few places Kaylo receives visitors. Unfortunately, Toora's inside man has not been able to plant the device.

Toora will propose that the player characters plant the bug. He will tell them that he can arrange for them to be let into the main private office section of the Delfi office complex. He will give them a map of the place if they will do this; he will share the information he gathers with the bug with the players; and he will pay them 10,000 credits. Toora will stress that this is the player characters' only hope of getting into the Delfi office building to see Kaylo, or to find out the truth about why Delfi Corporation might have engineered the attack on the *Terri Bear*. With no other options open, the players likely will agree; the gamemaster should make the prospect attractive enough that they do.

Toora's plan is as follows. That night, two hours after sunset, the player characters are to meet his agent at a vehicle lift entrance in the rear of the Delfi building. There, they will be given the bugging device and let into the building. All internal security will be bypassed by his inside man. They must plant the device directly under the main conference table and get out of the building by the same door within one hour.

If Toora gets the idea that the player characters' main interest is in Kaylo's chief bodyguard (T'Lovus), he will tell them that the guard's quarters are attached to the private wing. If they have time after planting the device, they can visit the guard's quarters, as long as they agree not to reveal the presence of the bug.

Toora will offer to have the group driven back to the spaceport in his armored cars, so they can get ready for the

mission. He will wish them luck, and will tell them to return to the warehouse office after noon the following day for their pay and access to any tapes made of conference room conversations.

PREPARING A PROPOSITION

If the characters do not return to the *Terri Bear* on their own for a conference with Salak after their meeting with Toora Delfi, Salak will call them by communicator and suggest they return.

After he learns of their chance to gather information from inside the Delfi organization, he will suggest that they proceed with the plan as outlined by Toora Delfi. Salak will suggest that the characters all go on the expedition because of "safety in numbers." He will suggest that, if they are caught, they will have to try to shoot their way out, and so he will suggest they go armed and carry one of the communicators in case of trouble. He will warn them not to use the communicator unless they are trapped with no other hope of escape, however, explaining that he does not wish to risk the signal being detected by security devices inside the office complex.

Salak will decline to accompany the group on the expedition, although he will promise to do whatever is necessary to pull them out if they are caught. He will warn them that he does not entirely trust Toora Delfi, but believes the Orion will keep his bargain as long as doing so does not directly endanger him. He will wish the group good luck. (This is a minor clue, but it might set the players thinking. Vulcans do not believe in luck, as the text of Sonam's letter reveals.)

If the player characters suggest the possibility that Kaylo's chief bodyguard is really T'Lovus masquerading as a Vulcan, Salak will admit the possibility somewhat reluctantly. *Under no circumstances* will Salak hint or suggest himself that the guard might be T'Lovus, though he will have figured this out long before the players do. He will (for reasons of his own, made clear later) not wish to let them know that he believes this. If the player characters suggest it themselves, he will go along with it to avoid making them too suspicious. If the players insist that the guard is important, Salak will suggest that they try and contact him, if they can do so without undue risk of discovery. He will warn them, however, that the renegade Romulan will not be easily convinced of the player characters' desire only to talk to him, and that the characters should be extra careful.

OUTCAST REDEEMED

For the trip to the Delfi building to meet with Toora Delfi's inside man, roll for random encounters as usual. This rolling is just for show and to make the players nervous. No matter what is secretly rolled, tell the characters that there is no encounter "...this time." At the appointed time, a lone Orion male will appear in the doorway, dressed in a guard's uniform. He will not give his name, but he quickly will usher the player characters inside and shut the vehicle entrance door.

He will give the player characters a small disk of metal, 6 cm across by ½ cm thick, with an adhesive strip on one side. This is the listening device, which the guard will tell them must be mounted under the center of the table. He will take them up a small personnel lift, lighted only by a dull red glow from a panel set in the roof. The guard will explain that he is on a regular set of rounds, so his movements will not be noticed, and that he has deliberately left security alarms and locks deactivated on the office floor. He will remind the group that they must be back at the lift door in

exactly one hour, so he can take them down and let them out when he returns this way again. When the lift stops, he will hurry them out into the hall and continue on with the lift.

THE CONFERENCE ROOM FLOOR

The Hallway

The hallway, half-darkened and appearing deserted, will be just as it appeared on the map the player characters were given by Toora Delfi. If characters have brought tricorders and try to use them, they will find that the devices no longer operate. Phasers, communicators and other electronic devices brought along also will fail to function, but the characters will not know any of this unless they try to use them.

The Conference Room

The conference room door will appear to be highly-polished wood, and will be unlocked as promised. As it swings, however, the characters will notice that it seems much heavier than wood. (Indeed, it is wood veneer over hullmetal.)

The room inside will be dark, but the half-light from the hall will shine in enough to illuminate a shadowy figure sitting in a chair at the far end of the table. If the characters have lights of their own, or turn on the room light switch next to the door, they will see that the figure is Kaylo Delfi, who sits facing the door, his eyes open but not moving, speaking, or reacting at all. If the player characters approach closer, they will see that Delfi is breathing shallowly and is glassy-eyed, as if drugged.

CONFRONTATION WITH T'LOVUS

The player characters will not have time for a closer examination of Kaylo Delfi, however, for suddenly the room lights will come on (if they weren't already) and a Vulcanoid man in an orange guard's uniform and holding a Klingon-style disruptor rifle will enter from another door; he will have some sort of sheath knife at his belt. Two Orions, similarly dressed and armed, will be with him. Their weapons will be out and ready, and they will seem quite capable of shooting anyone in the room.

"Sit down, all of you, or I will kill you," the Vulcanoid will order. "I understand you are looking for me. My name — when I still had one — was T'Lovus."



While he talks, the Romulan's aim will never waver. He will keep the player characters covered, grouped tightly, and will not allow them to spread out or catch him unawares. If anyone tries to draw or fire a weapon, the Vulcanoid smilingly will allow it, knowing that the character's weapons are useless. If any of the players thinks about having his character jump T'Lovus, however, discourage the action, pointing out that there is very little chance of getting to him without being shot. If he persists, T'Lovus will shoot him instantly.

Allow any player who decides to have his character try it a Saving Roll against his character's DEX score minus 20. If the roll succeeds, and T'Lovus fails a similar roll (but with no penalty), the player character can take ONE action (tackling the Romulan, trying to grab the weapon, diving under the table) before T'Lovus shoots.

Assuming there are no fireworks, or after the dust has settled, if there are, the renegade will then explain that he has been quite curious to meet the group who has been on his trail so tenaciously. To satisfy his curiosity, he will say, he allowed Toora Delfi's inside man to find a weak spot in his security, hoping to lure someone into his trap. He will inform the player characters that a device in the elevator burned out the circuitry of all transtator-based devices, including their phasers, tricorders, and communicators.

"There is more to this than a simple bit of corporate espionage, I am sure," T'Lovus will conclude. "Tell me why you have come."

If the player characters decide to make up a story, or if they stick to the idea of industrial espionage, T'Lovus will be impatient and angered, threatening to kill them all at once. If the characters tell T'Lovus of the UFP interest in recruiting him, his reaction will be one of barely restrained amusement.

"Your Federation — does it know so very little about the People after so many years? I am outcast by my society, but that is because my fellow Romulans are being led by weaklings and fools. I despise those individuals responsible for my status, but I do not abandon the Romulan Way! Indeed, it is THEY who have abandoned it. I have found allies, here, though," he will say, nodding at his companions. "I have managed to gain control of certain others," he will continue, with a nod at the drugged form of Kaylo Delfi. "Together, we shall purge the Star Empire of its weaklings and begin the most glorious chapter in the history of my people!"

The Romulan's Story

Whether or not the *k'manatram* continues his story depends on the reactions of the player characters. If they are belligerent and look like they will give T'Lovus trouble right away, he will decide to kill them immediately. In this case, the characters will have to jump him and the other guards and take their chances. If there are more than three player characters, and they do something clever to divert the Romulan's attention, they may have a chance, though one or more characters may be killed in the battle. Use the system outlined above for the renegade's first shot.

On the other hand, the player characters have nothing to gain by hurrying the Romulan at this point. They can expect no rescue, but they may be curious about the Romulan's plans. If they act interested, and make no threatening moves, the proud Romulan will be happy to tell them his story, as follows:

"I was once a powerful man in the Star Empire. I rose to prominence as a military officer because I would not compromise the Romulan ideal. It was my personal pleasure to denounce those of my superiors who showed weakness in the face of the enemy, and I was recognized for these achievements.

"But more and more of our leaders were soft and weak. They made us unworthy of our heritage. By the time I was

elected to the position of *d'safram* – a Grand Senator – our leadership was infested with these weak ones, aberrations who should have died at birth! When I tried to see that they were removed, one at a time, I was cast out by cowards not fit to be of The People!

"But it is not the Way that is flawed, only the leaders. I knew that once reminded of their heritage, my true equals among our people would rise up as warriors once more. The Road to the Stars cannot be stopped! So I stole a ship and made my way here. My intent was to find a way to manipulate power in this region, enough to plunge this part of the sector into economic chaos. The damnable Klingons would be sure to take advantage, and the UFP would not stand by and allow it. In this sector, there would be no interference from Organia to keep the two governments in line. Eventually, the Star Empire would be drawn into the conflict, and of course would prevail.

"My knowledge of Romulan shipping and defenses enabled me to ingratiate myself with those in power. Eventually I found this one, Kaylo Delfi. In a moment of misplaced trust, he boasted how he had blackmail information that kept most of his vastly-powerful family in line. His power and position could help me win my goal. Only your friend Toora was outside his control, but alone he could do little.

"I introduced Kaylo to a Romulan drug called N'levan, a strong hypnotic whose effects are cumulative. Little by little, his will was eroded until today he does whatever anyone tells him to do. Watch... Kaylo! Sing!" The seated Orion will begin a bawdy tavern song in the Orion language, continuing until T'Lovus tells him to stop. "Complex orders are harder, requiring much advance preparation, but I can even get him ready to run a board meeting and carry on long conversations without anyone knowing he is not his own master. Most of the time he sits, waiting."

THE FINAL CONFLICT

The explanation of Kaylo's drugged state is a broad hint to the players. Kaylo will respond to any direct order, even from them, as long as it is kept simple. Thus, if a player character orders Kaylo to grab the gun, attack T'Slak, or otherwise do something to cause a diversion, he will comply. If the player characters make use of this, they will be able to grab the initiative, giving them a series of actions before the Romulan and his Orion companions can react. If the characters have already jumped the guards and T'Lovus, in the second combat round, Salak will enter the room from behind T'Lovus and the Orions, calling out as described below.

If the characters do not take the hint, just as T'Lovus gets to the height of his speech, a thudding noise will be heard and T'Lovus will gasp in pain. The player characters will find that Salak has entered the room behind T'Lovus and thrown an ornate-looking knife into his back. T'Lovus will probably not be killed by the attack (roll ordinary knife damage), but the shock and surprise will make him drop his weapon.

Salak will no longer be dressed as a Vulcan, but will be wearing full Romulan military garb, though with no sash of rank or insignia; he will bear another ornate knife at his belt. "*Manda, vang'radam!*" he will shout, using his native tongue. "*Na cl'vangam Rom'Inz! Sav k'manatram ta mandi k'manatram.*" If any of the player characters have a Skill Rating of 20 or more in *Romulan Language*, provide the following translation: "I see you, traitor! This is the People's revenge! Only the unseen can see the unseen."

The Orion guards will recover quickly and turn their weapons on Salak, if possible, and the fight will be on. During this combat, the gamemaster should make rolls for targets and hits secretly, weighting the fight so that Salak takes much of the punishment away from the players. Remember that

the players' weapons do not work, and Salak is armed only with the two knives. T'Lovus' dropped weapon is functional, however, if it can be retrieved, but the guards' disruptor rifles cannot be aimed against someone in brawling range, and so will be useless except as clubs.

T'Lovus will fight to the death or unconsciousness. The two guards will surrender if either is wounded and T'Lovus is out of the combat.

THE STORY OF T'SLAK

When the fight is over, it is likely that Salak will be hurt badly. Even if the dice say that he should be unconscious, however, he will remain communicative long enough to explain the plot to the player characters.

"I am no Vulcan," he will finally admit. "My name was once T'Slak, and I was a Commander of a Romulan warship. T'Lovus was my second-in-command. Once, I spared a Federation ship found in the Neutral Zone. Another Federation ship had seen the encounter, and to destroy the first ship would have meant war. We were not ready for war.

"But T'Lovus brought me before a court-martial board and insisted on the letter of the law. Though my superiors knew I had acted in the best interests of the Star Empire, the evidence left them no choice. I was stripped of my name and family and made one of the *k'manatri* – the unseen ones.

"Even so, those in power made it possible, in ways that protected their honor, for me to escape Romulan space. A number of times, I have acted as an intermediary – totally unofficial and untouchable – between my government and the Federation, mostly through contacts with our Vulcan cousins. The Star Empire does not acknowledge me, but they will send word to those who know how to find me when it is needful that they find out things only I can tell them. In this way, I hoped to regain my honor and my name.

"When word reached me that T'Lovus had been cast out, I knew he would not rest until he had regained his honor with blood. The Empire could not afford to let him live, but could not recognize him long enough to kill him without sacrificing honor. But if I could do this, I could redeem my name by serving the Star Empire.

"Your Federation knew of my mission, but could not acknowledge me either. It would have been politically unwise for a Federation official to admit he allowed an avowed Romulan agent to run loose. But only I could identify T'Lovus. So I posed as a Vulcan, and acted as an agent invisible to BOTH my employers.

"Now, my name and honor are restored. I am T'Slak of Romulus, Commander in the Imperial Fleet. And I am content."

With these words, T'Slak will lose consciousness. If he is badly wounded enough, he will now die. If he has not yet been this badly wounded, and the gamemaster wishes to keep him alive for further encounters, he will regain consciousness with proper medical attention. If the gamemaster does not wish him to live, T'Lovus can have enough life left in him to grab a gun and kill T'Slak before dying himself, or another loyal guard may enter and do the job before surrendering in the face of overwhelming odds.

Either way, the guard sent by Toora Delfi will soon arrive. He will explain that Toora and T'Slak had made a deal, and that the characters were the bait to draw T'Lovus into the open. He will say that Toora is on his way, coming to take charge of his helpless kinsman Kaylo. The player characters likely will infer that Toora will use Kaylo's power as T'Lovus did, but with the aim of restoring the economic balance and, no doubt, enriching himself as well.

The guard will tell the player characters they must leave before the company police catch on, and he will lead them out the way they came, along with T'Slak, if he still lives. If

T'Slak is dead, the player characters can leave the body behind, for the guard will promise that Toora will see it is returned to Romulus with appropriate honors. A groundcar, driven by one of Toora's guards, will be waiting to take the characters back to the *Terri Bear*.

THE VULCAN CONNECTION

This encounter will conclude the adventure, tying up all the loose ends. Because the exact circumstances of any particular play-through cannot be predicted, the encounter will have to be altered to take into account various possibilities.

T'SLAK DEAD

Upon return to the *Terri Bear*, two Vulcan males will be waiting for the player characters. The Vulcans will introduce themselves as Commanders Sanla and Sophik of Star Fleet Intelligence, and they will produce sufficient identification to prove their identities. They will inform the player characters that they are part of the effort that sent T'Slak to Bonus Run in the first place. Furthermore, Sanla will reveal that he is acquainted with the lead character's friend Sonam, and he will quote the exact contents of Sonam's original message to prove it.

The two officers will thank the characters for their efforts, and apologize for not telling them the whole story at the start. They will tell the lead character that Sonam was in favor of telling him the whole story, but Sonam's faith in his friend was not shared by others in the intelligence community, who certainly know better now. The intelligence officers will tell the player characters that it is their job to get things returned to normal, including giving Toora Delfi the help necessary to restore economic strength to this part of the sector.

The player characters will be informed that their silence is absolutely vital. Any discussion of this matter at any time will result in very severe penalties, which the two Vulcans will not discuss. The player characters will be assured that their actions have helped to preserve peace, which should be enough compensation for their silence. (If any of the player characters DO talk later, the gamemaster should feel free to have Star Fleet officers court-martialled on trumped-up charges, or independent characters hounded and harassed unmercifully by both Star Fleet and the Romulan Star Empire.)

If the characters are independent traders, the gamemaster may wish to have the two Vulcans present the crew with the *Terri Bear* in thanks for their aid. Certainly any promise of pay will be met at this time. If the player characters are Star Fleet officers, they will be asked to return the *Terri Bear* to Levitt's World and return to duty. Commendations will be entered on their records, but, because the mission is still secret, these will appear only on documents at the highest levels.

The adventure will end when the player characters return to Levitt's World. Star Fleet characters' shipmates will find it curious that their ship's schedule was held up so long here by official red tape, or that the player characters just happened to return from vacation only hours before the ship gets orders to continue its normal patrol. Independent traders will find they get treated with a great deal of respect by local officials. Either way, the status of the player characters will improve by virtue of their successful completion of the mission. Lower-level bureaucrats will remain unaware of their achievement, but the next high-level dealings they have (with Star Fleet, the Vulcan government, or the Star Empire) should go smoother (at gamemaster's option) because their reputations will have preceded them.

T'SLAK ALIVE

If T'Slak is still alive, a Vulcan female will accompany the two intelligence officers, whom T'Slak will vouch for, saying that he is acquainted with them. The Vulcan female will not be introduced, but will tend to T'Slak and others who are injured with great skill.



In this case, the *Terri Bear* will not be given to independent trader player characters, as T'Slak will need it to return to Romulus. Other transport back to Levitt's World will have been arranged for the player characters. Either way, any promises of payment will be met at this time.

Before all part company, T'Slak will wish his companions well, stating that he hopes that they will not meet in battle, but in friendship. "The Road to the Stars stands before us all," he will say. "Many of us do not believe that the Road has only one direction, or that only Romulans can walk it. Perhaps someday that view will be shared by both our governments. In the meantime, farewell."

REVISIONS TO THE ADVENTURE

It is possible that the actions of the player characters early in the adventure may keep them from continuing with Salak to Bonus Run. This can happen if the characters fail to make contact with Salak, refuse his offer, or later cause trouble with the police and are arrested. If the player characters do not go with him, Salak will go on alone, unbeknownst to the player characters. He will be recognized during his early scouting and will be killed by T'Lovus, thus his mission will fail. This is not the end of the adventure, though the beginning has been delayed a bit. This section will allow the gamemaster to get the players back into the plot.

A SECOND MESSAGE FROM SONAM

About one month after Salak leaves for Bonus Run, the characters' ship will again be detained at the nearest port. This time the lead character will be contacted by two Star Fleet intelligence officers, both Vulcans. The officers will give

the character a voice and vision recording sent by his/her friend Sonam. The text of this message, delivered by Sonam in a grave tone, is as follows:

My Friend,

It is tragic that your connections with Salak went so poorly. I do not know what happened, but I know you must have had your reasons for not following him. Know now that Salak is dead, and I must again turn to you for help.

Salak the Vulcan was actually a Romulan outcast once named T'Slak, a highly-placed officer with their fleet before his fall. Circumstances made it necessary for the Romulan government and our own Federation to cooperate, though neither government could do so openly. T'Slak hoped to regain his lost honor by finding and assassinating another outcast named T'Lovus. This renegade is a dangerous extremist, who apparently intends to find a way to spark a war in this sector.

We do not know of T'Lovus' exact location, though he is known to be on Bonus Run. Nor do we know how he intends to accomplish his goals. We know of his plans only because T'Slak managed to leave behind notes made before his death. The only hope we have of containing the situation is to smuggle in a group of agents disguised as independent traders. Our own agents in Star Fleet intelligence may be compromised, and so we must look for volunteers.

I have disobeyed orders to tell you as much as I have, and I will surely lose my commission because of it, but it will be worth the price if war can be averted. These agents will aid you, but they cannot accompany you on this journey. Take only those you can absolutely trust. Jump ship if you must. But do what you can to end this threat. I will do all I can to cover your absence. I cannot stress enough that this is important to the peace of the galaxy.

Good luck to you, and may T'Slak's warrior soul find peace in whatever place his gods have prepared for him. In this life, he gave all he had to attain that peace, and failed.

Sonam out.

The agents are Commanders Sanla and Sophik, who were working with Salak. They can bring the lead character and the team he selects to the *Terri Bear's* berth. (T'Slak took other transport, because he was travelling alone.) Before they leave, they will give the player characters the same briefing (detailed in **Briefing**) that Salak would have given enroute.

Should the characters refuse to cooperate even this second time, intelligence agents Sanla and Sophik are quite capable of making the characters' lives miserable until they agree to take on the mission. Such harassment can include transfers to other duty if they are Star Fleet officers, or trouble with local port officials if the characters are independent traders.

EVENTS ON BONUS RUN

On Bonus Run, the player characters will have to face the situations described in the adventure, with a few exceptions, as detailed below.

In this case, because Salak contacted the black market dealer Cevlac Loban, who sent him to the apothecary Jaclan Uvane, Uvane will be expecting the player characters. When the player characters follow in Salak's footsteps, they will fall into the ambush described in **Trap!** the first time they walk into Uvane's shop.

If the characters manage to contact T'Lovus, they can still bluff with an offer of alliance, but their mission is to kill or attempt to capture him. Capturing him will not be possible, as he will not under any circumstances be taken alive. Because Salak is dead and cannot provide the diversion described in , Toora Delfi's inside man may do so if the characters are in a jam.

Finally, if the characters succeed, they will receive no special compensation. High-level manipulation will prevent them from getting in trouble if they have jumped ship, but that is all.



Background Information

The information contained under each of the separate subheadings in this chapter is available to the player characters through their shipboard computer. As indicated in each section, some of this information has been provided by Salak, and the rest will be available if the ship's computer is hooked

into the datanet on Bonus Run. All of the information is available from any commercial terminal on Bonus Run. Except for the background information provided by Salak, the players must initiate their own computer searches in order to gain access to each piece of data.

BONUS RUN

This information is provided by Salak, and so it is available for inspection during the trip to Bonus Run.

WORLD LOG

System Name: LYANNT

Number of Class M Present: 1

World Name: BONUS RUN

Position in System: 3

Number of Satellites: 0

Planetary Gravity: 0.8 G

Planetary Size

Diameter: 10,400 km

Equatorial Circumference: 32,000 km

Total Surface Area: 408,000,000 sq. km

Percent Land Mass: 43%

Total Land Area: 175,440,000 sq. km

Planetary Conditions

Length of Day: 24 hours

Atmospheric Density: Normal

General Climate: Desert

Mineral Content

Normal Metals: 39

Radioactives: 42

Gemstones: trace

Industrial Crystals: 11

Special Minerals: trace

LIFE AND CIVILIZATION LOG

World Name: BONUS RUN

Technological/Sociopolitical Index: 999893-74

Planetary Trade Profile: BDEFACF/G (C); Trade Center

Noteworthy Facts:

Bonus Run, first discovered and named by UFP independent scouts, was granted to Orion colonial control by the UFP/Orion border agreements of Stardate 1/9903.21. An Orion development grant was given Stardate 2/1201.03 to Bonus Run Corporation for private operation as a tradeworld chartered under Orion jurisdiction, but outside of normal Orion holdings. The Bonus Run Corporation's stock is scattered among a number of holding companies, but control rests with the Orion-based Delfi Corporation. Government is completely in the hands of the corporation, under a semi-feudal system.

The major income of the planet is based around its use as a trade base, most of the planet being inhospitable desert. Most of the population is clustered around the major spaceport, with a few mining operations and manufacturing complexes located elsewhere. The spaceport is called Bonus Run Central Spaceport, with the surrounding town known as Bonus Run Center.

Most trade items sold here are exported elsewhere, accounting for the relatively high consumption rating on a world with a small population, mostly transient. This situation is not uncommon on tradeworlds.

DELFI CORPORATION

This information is provided by Salak, and so it is available for inspection during the trip to Bonus Run.

Chartered Stardate 1/9502.01 under Orion jurisdiction, the Delfi Corporation is family-owned, like most Orion corporations. The fledgling firm made a big splash in the financial world early when they arranged to take over a played-out mining claim on Rahli V, and used new mining techniques purchased from Romulan sources to strike new veins of uranium ore.

Financially flush from this success, and bolstered by the good publicity it engendered, the corporation acquired voting control of the tradeworld development firm that had secured an option for operating the planet Lyannt III (Bonus Run) as a tradeworld. Again showing a flair for the innovative, the tradeworld was opened to trade traffic, and large incentives paid to brokerage firms that agreed to locate there. The move almost bankrupted the company, with Delfi Corporation leader Toovi Delfi narrowly winning a vote of confidence

to remain in power. The incentive program paid off in the long run, however, quickly elevating Bonus Run to favored status among Triangle-border tradeworlds.

Toovi Delfi's influence, however, waned after the vote of confidence. He died at his own hand several years later, and his branch of the family was unable to retain control of the firm. The current corporate leader is Kaylo Delfi, though Toora Delfi, son of the late Toovi, remains active in corporate affairs and controls the loyal opposition to the current corporate leadership.

UFP intelligence notes that policies of the Bonus Run corporation have changed in the last year, with the result being a strong decline in trade revenues. Several otherwise-strong brokerage and transport firms in this area have suffered as a result of these changes, with at least two major firms going bankrupt. The economic stress thus created makes the area a place to be watched, because such stress can lead to Klingon intervention and conflict.

KAYLO DELFI

This information is only available from the Bonus Run datanet.

Kaylo Delfi is the current chief executive officer of the Delfi Corporation, which has the controlling interest in the Bonus Run Development Corporation. He is one of the youngest men ever to head the powerful Delfi family, inheriting the mantle from his father at the age of 19 when the senior Delfi was killed in a tragic street accident. Kaylo is now 34, and remains unmarried.

Delfi, a recluse refusing most interviews, seems to take particular pleasure in being a man of mystery. His hold over his family corporation is inexplicably strong, despite the fact that there are a large number of Delfi family members senior to him in years and in service with the company. Because of this he holds most of the proxies within the family, unusual because his personally held stock is smaller than that of Toora Delfi, who heads his most vocal opposition.

TOORA DELFI

This information is only available from the Bonus Run datanet.

Toora Delfi is the eldest son of the late Toovi Delfi, former chief executive officer of the Delfi Corporation. Groomed by his father to take over the family business, but denied this after his father's suicide, Toora's early training in the business came as a broker under his father's tutelage. Known and respected by many old-time traders in the region, he is middle-aged with a wife, Laven, and a young child.

Though he personally holds the largest single block of Delfi corporate stock, he currently controls only the relatively minor Small Lot Brokerage portion of the family business. Voting control of most of the family's stock is in the hands of Kaylo Delfi, the current executive officer. Toora Delfi, as head of the most vocal opposition to Kaylo Delfi, is constantly at odds with the corporation's chief executives, and he maintains only a tenuous hold on a small part of the corporate stock.

BONUS RUN'S HIGH MARKET

This information is provided by Salak, and so it is available for inspection during the trip to Bonus Run.

Just as it is on most other Orion-founded worlds, the High Market is the traditional center of legitimate trade on Bonus Run. Though it is open to any trader, regardless of origin, much of the trading is done through resident brokers, mostly Orion. The market, which is located in the Merchant's Quarter, is open and usually busy all day and night. Street vendors and local retail shops are located there in addition to brokerage house offices.

SHADOW MARKETS ON ORION TRADEWORLDS

This information is available ONLY from the ship's library computer. It cannot be accessed from the Bonus Run datanet.

On Orion trade ports, the so-called Shadow Market is traditionally an area where semi-legal and illegal transactions and activities are common. Shadow Markets are congregating places where contacts for various illegal dealers can be located. These contacts sometimes work for specific dealers, or are freelance go-betweens who are paid a percentage of the profits by any local black marketeer to whom they bring a client. Deals made in the Shadow Market, especially with contacts, usually conclude with no names having been exchanged. Technique and experience are important when 'working the shadows,' with inexperienced traders often being cheated, or even robbed.

Most local officials allow Shadow Markets to exist, as long as those who reside and do business there do not allow their activities to spread or endanger the free trade such worlds depend upon.

MAPS

This section contains complete floorplans of the *Terri Bear*, the offices of Cevlac Loban, the apothecary shop of Jaclan Uvane, and the inner office floor of the Delfi Corporation. It also includes an area map of Bonus Run Center, showing the relative placement of all encounter locations. There are two copies of this map, one for player characters and one for the gamemaster. All other potential combat situations, such as at the Loban warehouse, on the street, and in front of the Delfi Small Lot Brokerage offices, occur in mostly open areas and can be played using a blank half-inch grid.*

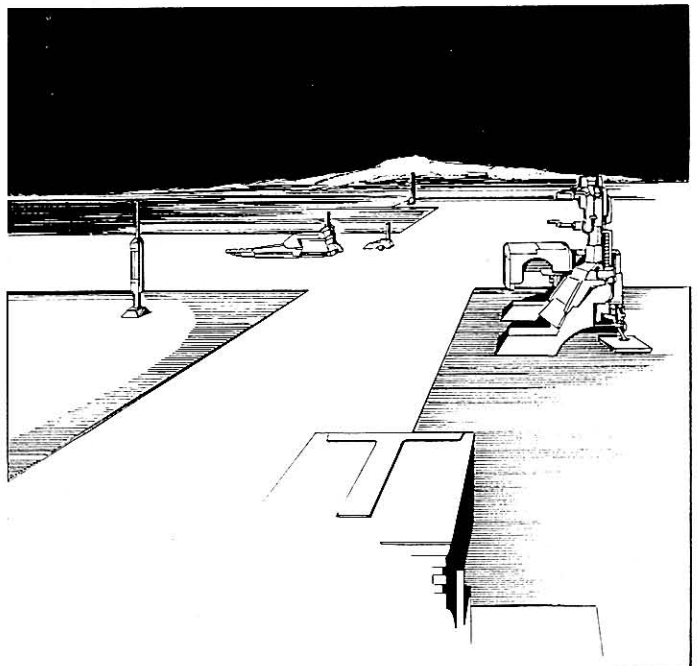

Cast of Characters

These detailed character records of the major NPCs are intended for the gamemaster's use only, and are not meant to be provided to players.

Name: TOORA DELFI

Title: Chief Small Lot Broker
Corporation: Delfi Corporation

Race: Orion
Age: 57
Sex: M

Attributes

STR —43	CHA —62
END —49	LUC —40
INT —78	PSI —15
DEX —35	

Combat Statistics:

To Hit Numbers:	Bare-Hand Damage:	1D10
Modern: 22	AP:	7
HTH: 33		

Significant Skills

	Rating
Bribery	22
Carousing	54
Leadership	77
Marksmanship, Modern	10
Negotiation/Diplomacy	43
Personal Combat, Unarmed	31
Streetwise	61
Trade And Commerce	84
Value Estimation	66

Distinguishing Physical Characteristics:

Toora is 5'11" tall and weighs 187 lbs.

Brief Personal History:

Son of the late Toovi Delfi, former chief executive officer of the Delfi Corporation, and holder of the largest single block of Delfi stock, Toora Delfi heads the loyal opposition within the Delfi family. He received his training as a trader under his father's tutelage, and his is widely respected.

Personality:

Motivations/Desires/Goals:

Toora believes that his father was unfairly eased out of corporate control. He lost his chance to be head of the family after his father's suicide, and he wants what his father intended for him. He looks at Kaylo Delfi as a dangerous opponent, but he does not really hate him. A strong family man, Toora thinks of himself as protector of his descendants.

Manner:

Toora is very cautious, believing himself and his family in danger from his cousin or his cousin's men.

Special Knowledge/Powers:

None.

Name: T'SLAK (SALAK)

Rank/Title: Commodore (Stripped Of Rank)

Race: Romulan posing as Vulcan

Age: 49
Sex: M

Attributes

STR —63	CHA —57
END —72	LUC —31
INT —65	PSI —29
DEX —59	

Combat Statistics:

To-Hit Numbers:	Bare-Hand Damage:	1D10+3
Modern: 56	AP:	9
HTH: 59		

Significant Skills

	Rating
Computer Operation	35
Environmental Suit Operation	16
Language	
Galacta	47
Orion	23
Vulcan	49
Leadership	78
Marksmanship, Modern	53
Negotiation/Diplomacy	62
Personal Combat	
Unarmed	60
Knife	43
Starship Helm Operation	71
Streetwise	69

Distinguishing Physical Characteristics:

T'Slak is a distinguished looking Vulcanoid of middle years. He is 6'4" tall and weighs 183 lbs.

Brief Personal History:

As a former commander of a Romulan warship, T'Slak decided not to destroy a UFP ship inadvertently straying into the Neutral Zone. Though his only intent was to avoid interstellar war, he was denounced by a junior officer named T'Lovus. In the subsequent investigation, he was declared to be a *k'manatram*, or outcast. He left Romulan space and has since unofficially investigated situations on behalf of Romulan interests, though he cannot return to Romulan space or interact with Romulans who know his status.

Personality:

Motivations/Desires/Goals:

T'Slak's strongest desire is to regain his name and honor by accomplishing some great goal for the Star Empire. He is a warrior born, but believes that war ending in destruction for both sides is stupid and futile. He is, however, a strong believer in the Romulan Way, and he will die to defend it.

Manner:

T'Slak is a patient individual, and he does not believe in foolish bravado. He is willing to wait and gather information until he knows a situation before acting.

Special Knowledge/Powers:

None.

Name: T'LOVUS (SLAGH)

Title: Grand Senator (Stripped of title)

Race: Romulan posing as Vulcan

Age: 43

Sex: M

Attributes

STR —66 CHA —59
END —68 LUC —35
INT —62 PSI —15
DEX —73

Combat Statistics:

To-Hit Numbers: Bare-Hand Damage: 1D10+3
Modern: 67 AP: 11
HTH: 57

Significant Skills

	Rating
Marksmanship, Modern	61
Personal Combat, Unarmed	42

Distinguishing Physical Characteristics:

T'Lovus has dark, deep-set eyes in a hawk-like face. He is 6'6" tall and weighs 195 lbs.

Brief Personal History:

T'Lovus rose to prominence in the Romulan space service by denouncing superiors who showed any weakness toward enemies. He became a Grand Senator, but was declared *k'manatram* for betraying a fellow officer and falsifying evidence. Now passing as Slagh, he is Kaylo Delfi's chief bodyguard. Because he is an outcast, he cannot return to Romulan space or interact with Romulans who know his status.

Personality:

Motivations/Desires/Goals:

T'Lovus believes the Romulan Way has become polluted by those who would abandon war for diplomatic solutions to problems. He is not bitter about the Romulan Way, but rather believes his fall from power is a result of the weakness of a few Romulans currently in power. He hates all things non-Romulan, but he is capable of great patience and forbearance to reach a set goal.

Special Knowledge/Powers:

None.

Name: CEVLAK LOBAN

Occupation: Black Marketeer

Race: Orion

Age: 61

Sex: M

Attributes

STR —38 CHA —53
END —37 LUC —39
INT —62 PSI —01
DEX —41

Combat Statistics:

To-Hit Numbers: Bare-Hand Damage: 1D10
Modern: 34 AP: 8
HTH: 33

Significant Skills

	Rating
Forgery	38
Language, Galacta	82
Marksmanship, Modern	28
Negotiation/Diplomacy	33
Personal Combat, Unarmed	25
Streetwise	81
Trade And Commerce	77
Value Estimation	69

Distinguishing Physical Characteristics:

Loban has a fringe of white hair and a nervous appearance. He is 5'10" tall and weighs 145 lbs.

Brief Personal History:

A long-time black market dealer, Loban can obtain or sell nearly anything on the Shadow Market, operating out of his front business, Loban Trade Advisors.

Personality:

Motivations/Desires/Goals:

Loban would like to build a black market dynasty, and is well on the way to doing so.

Manner:

Loban is relatively honest for an Orion, favoring in his dealings those who deal fairly with him. He will never forget a person who cheats him, and he hates ingratitude. He is devoted to his twin sons Dabal and Dabri.

Special Knowledge/Powers:

None.

Name: DABAL and DABRI LOBAN

Race: Orion

Occupation: Muscle

Age: 28

Sex: Male

Attributes

STR —74 CHA —47
END —63 LUC —13
INT —31 PSI —11
DEX —50

Combat Statistics:

To-Hit Numbers: Bare-Hand Damage: 1D10+3
Modern: 40 AP: 9
HTH: 56

Significant Skills

	Rating
Marksmanship, Modern	30
Personal Combat, Unarmed	62
Streetwise	33

Name: JACLAN UVANE

Occupation: Apothecary/Drug Dealer

Race: Orion

Age: 69

Sex: Male

Attributes

STR —31 CHA —28
END —38 LUC —15
INT —66 PSI —01
DEX —41

Combat Statistics:

To-Hit Numbers: Bare-Hand Damage: 1D10
 Modern: 26 AP: 8
 HTH: 25

Significant Skills

	Rating
Bribery	68
Forgery	15
Life Sciences, Botany	88
Medical Sciences, General Medicine	28
Streetwise	79
Trade And Commerce	68
Trivia	
Poisons	44
Street Drugs	75

Distinguishing Physical Characteristics:

Uvane's wizened appearance causes him to appear to be even older than he is. He stands 5'4" tall and weighs 130 lbs.

Brief Personal History:

Uvane uses his apothecary shop as a front for dealing illegal drugs, which he buys mostly from outsystem traders. He sells mostly to non-Orion transients, so local officials have left him pretty much alone. Currently he has been retained by T'Lovus to prepare the hypnotic drug used on Kaylo Delfi.

Personality:

Motivations/Desires/Goals:

Uvane is a conscienceless opportunist.

Manner:

He is a casual liar who will do whatever necessary to protect his interests. He is easily frightened and intimidated by a show of physical force. He does not tolerate pain, or the threat of pain, well. He will not betray T'Lovus, only because he is afraid of the Romulan.

Special Knowledge/Powers:

None.

Occupation: Generic Bartough Or Guard

Race: Orion

Age: 30

Sex: Male

Attributes

STR —65 CHA —30
END —50 LUC —30
INT —40 PSI —01
DEX —55

Significant Skills

	Rating
Marksmanship, Modern	30
Personal Combat	
Knife	40
Unarmed	50
Streetwise	30

Combat Statistics:

To-Hit Numbers Bare-Hand Damage: 1D10+3
 Modern: 42 AP: 9
 HTH: 52

Gamemaster's Notes

HINTS ON PLAY

MEETING WITH SALAK

The gamemaster may need to make several secret Skill or Saving Rolls while explaining the situation in his role as Salak. Certain party members present have a chance to observe and gain information if they have the proper skills and experience. These rolls should be prepared for ahead of time, so that the gamemaster does not need to consult any papers and perhaps spoil the role-playing of the encounter. The information from such secret rolls can be written as notes beforehand, allowing the gamemaster to pass them out while the encounter is progressing. This allows the information to be dealt with through role-play, rather than through mass-mind problem solving. It also increases the suspense and the game's danger quotient.

Salak's Body Language

The gamemaster should make a secret Saving Roll against the INT score for any character whose data record shows clearly that he has had extensive experience with Vulcans in a predominantly Vulcan environment, such as living on a Vulcan colony world, or being assigned to a ship manned primarily by Vulcans. Vulcan player characters will receive this roll automatically. This roll should not be announced, nor should the players be asked if their characters have had such experience. If it has not been established through play or on the character sheet that a character has had this experience, assume he does not. If the secret Saving Roll is successful, the player should be told, secretly, that he notices that, though Salak is not overtly friendly, his body language marks him unusually emotional for a Vulcan. He does not, for example, maintain as much personal distance as most privacy-conscious Vulcans are known to do. One explanation for this is that Salak has possibly lived and worked extensively with Humans (or others) who are not as conscious of personal space as Vulcans.

Similarly, the gamemaster should make a secret Skill Roll for any player characters with skill in *Vulcan Culture and History*, making the roll against the character's rating in that skill. If the roll succeeds, the player should be told, secretly, about Salak's body language, as above.

Salak's Speech Patterns

The gamemaster should make secret Skill Rolls for any characters who have skill in the *Vulcan Language*, making the rolls against half the Skill Ratings in that skill. No roll is necessary for Vulcan player characters, the information coming to the character automatically. If the Skill Roll is successful, the gamemaster should secretly inform the player that Salak speaks the Federation standard language flawlessly, but he has no trace of a Vulcan accent, indicating that he was not raised among Vulcans.

Similarly, the gamemaster should make secret Skill Rolls for any characters who have skill in the *Romulan Language*, making the rolls against half the Skill Ratings in that skill. If this roll succeeds, the gamemaster should secretly inform the player that Salak speaks Romulan quite well, with no trace of an accent. This will lend credibility to his claim to be a Romulan expert.

PURCHASING LOBAN'S STARSHIP SENSORS

It is possible that the player characters will purchase the starship sensors and other instruments T'Lovus sold to Loban, intending to ship it to the UFP (perhaps at a profit) when their mission is over. As a Romulan, with the Star Empire's interests at heart, Salak/T'Slak will not be pleased about this possibility, for it will give the UFP and Star Fleet intelligence they might not have about Romulan starship capabilities. Thus, if left alone in the ship with these instruments, he will remove or sabotage various important circuits, making the stuff virtually worthless to the UFP.

The player characters will not catch this unless they inspect the cargo later. In this case, to determine if the sabotage has been spotted, make a secret Skill Roll against the inspecting player character's rating in *Starship Sensors* minus a penalty of 30 points. If the roll is successful, the character will have discovered the sabotage, and the gamemaster will have to wing it from there.

CONFERENCES IN THE TERRI BEAR

At any time the player characters uncover evidence that they want to discuss with Salak, they may attempt to have a conference with him by communicator. The Vulcan, not trusting the scrambling more than necessary, will not wish to have any lengthy planning sessions by communciator, and will suggest the crew return to the ship for a conference. Alternatively, if the player characters have made contact with at least two major sources (Loban, Uvane, bartender Kladd, or Toora Delfi), but have not contacted Salak, the gamemaster may desire to have Salak call them and suggest a conference at the ship.

Much of what occurs in these conferences will depend on which leads the player characters have pursued. Certainly, Salak will ask for a complete run-down on the player characters' activities.

Salak will be disapproving if the player characters have drawn too much attention to themselves, especially if Jaclan Uvane or his assistant escaped from the encounter detailed in **Trap** or the Delfi toughs escaped in the encounter detailed in **Ambush**. He will say that it is unfortunate they were not able to prevent them from warning their quarry, because now he will be more difficult to approach. If it is pointed out that the only way to prevent this from happening would have been to kill Uvane, Salak will look momentarily confused. "Yes," he will say after a moment's hesitation. "Of course, we would not want that." His tone will not be particularly convincing, because Salak believes that killing a potentially-dangerous foe like Uvane is the only reasonable course a Romulan would take. But he realizes he is posing as a Vulcan, and must keep up a Vulcan-like pose of non-violence.

If tales of dissension within the ranks at Delfi reach Salak, he will suggest that contacting the leader of the opposition to Delfi's current management might be useful, since the outcast seems to be working with the group in power. Computer research, which Salak will suggest if the player characters have not already done it, will show that Toora Delfi is now running the family corporation's Small Lot Brokerage in the Merchant's Quarter. Using this information, the player characters can decide to visit Toora, which will further the plot.

It is possible that the characters have already contacted Toora Delfi. If so, their findings can be reported to Salak at this time. This will set the stage for the **Outcast Redeemed**.

BONUS RUN

LAWS AND CUSTOMS

Though slave trade in green Orion females is officially ended on Orion worlds in Federation space, those restrictions are not necessarily enforced on Bonus Run, which lies effectively outside the direct control of the UFP.

Bonus Run has no restrictions against hand weapons, though the carrying of larger weapons is frowned upon.

THE SHADOW MARKET

The gamemaster should be familiar with the Data Bank entry on The Shadow Market, as well as the trading techniques described in the adventure text. If the players are using experienced trader characters, they should be warned about having their characters discussing the shady nature of the place too openly, something their characters would know not to do. On the other hand, if the players are using Star Fleet characters, the characters might well be unfamiliar with the proper ways to ask around about such a place. To determine if this is the case, make a secret Saving Roll against the greatest Skill Rating in *Streetwise* among the player characters. If the roll fails, you need not concern yourself with warning the players about being discreet, and you might even have a potential source of information clam up, afraid the characters' big mouths will get him into trouble.

MAPS

This section contains complete floorplans of the *Terri Bear*, the offices of Cevlac Loban, the apothecary shop of Jaclan Uvane, and the inner office floor of the Delfi Corporation. It also includes an area map of Bonus Run Center, showing the relative placement of all encounter locations. There are two copies of this map, one for player characters and one for the gamemaster. All other potential combat situations, such as at the Loban warehouse, on the street, and in front of the Delfi Small Lot Brokerage offices, occur in mostly open areas and can be played using a blank half-inch grid.

SIGNPOST ENCOUNTERS

Occasionally, a gamemaster will find that the players have allowed their characters to stray into a series of actions that is totally removed from the main thread of the adventure. A certain amount of this is fine – it adds interest to the adventure, especially if the gamemaster can think on his/her feet and come up with interesting encounters and side-adventures.

Eventually, however, the gamemaster will want to put the characters back on the track. A suggested *signpost encounter* is included for each major area of the port city, which the gamemaster can use to point the way for characters back to the main adventure. Information imparted by these encounters can be gained in other ways, but these encounters will serve to get the characters back into the main action if they wander too far afield.

Signpost encounters are not as detailed as other encounters. Gamemasters are encouraged to elaborate on the material presented in any way necessary to return the players to the main track of the adventure.

SPACEPORT

The player characters will see Human trader with a heavy-laden a-grav platform stopped by three Delfi corporation guards, who confiscate the harmless shipment of Antarean Glow Water he has, claiming it "doesn't meet purity standards." The trader will be outraged, bellowing and arguing. He will claim to know nothing about purity standards and neither does anyone else (there are none), and a fight will break out as he tries to prevent the guards from taking the cargo. Unless the player characters interfere, the trader will be subdued quickly and beaten senseless by the guards, and the cargo will be taken. One guard will give the man a last brutal kick in the side and growl that next time he "should be more careful buying from Toora."



If the player characters get involved in the fight, the guards will back off, not wanting to attract too much attention with what is obviously a phony charge. They will "decide to refer the matter to the proper legal authorities" and leave. The grateful trader, Jasper DeLeon by name, will offer to buy the characters a drink at the nearest bar, as soon as he drops off his cargo at his one-man ship.

If the characters do not fight, but help the injured man obtain medical attention, he will require hospitalization. (The local medical facility is privately owned, but not by the Delfi Corporation.) A few hours after he is checked in, he will be in shape to talk, but will not be able to travel for many days. If the characters don't wait around, Jasper will send for them.

In either case, Jasper will tell them that he has been buying small lots of trade goods from the Delfi Small Lot Brokerage for many years, to be shipped in his one-man cargo vessel. Recently, he's been under a lot of pressure from the main branch of Delfi Corporation to buy small lots directly through their main offices. Apparently, there is a power struggle within the company. The trader continued to buy from Toova Delfi, who is well-known to most long-time traders.

Jasper will not join the group if they ask, as he must leave planet as soon as possible to avoid paying large penalties on his cargo. The gamemaster may wish to keep him in mind, however, as a contact for later adventures.

VISITOR'S QUARTER

A seedy-looking Orion will approach one or more of the characters, offering to sell a small quantity of a legendary perfume, *Plenda Essence*. The Essence is the subject of an

old legend well-known among humanoids in Orion space. Supposedly, it was formulated many years ago using distillates extracted from musk glands only possessed by green Orion slave women. As removal of the gland resulted in the death of a slave, the distillates were very rare indeed. According to the legend, the perfume made from these distillates, when worn by a humanoid woman, would affect humanoid males in the same manner as the natural pheromone attractant in the green Orion females.

The secret of how the substance was made is long forgotten, and it may not have existed at all. Even so, every few years a rumor goes around Orion space that some wealthy patron or another has managed to find a forgotten cache of the Essence. If the Essence exists at all, there are certainly many wealthy women who would pay handsomely for it. Unfortunately, to discourage flocks of get-rich-quick schemers from inundating Orion space, the Orion family heads have outlawed the possession of Plenda Essence, formulas for its manufacture (phony or or not), or any trade in information about the substance.

The Orion who approaches the characters, dirty and raggedly dressed, will not seem to be the sort who would have such a prize. Still, he will insist he can prove his claims if the characters will accompany him to his hotel.

In a seedy hotel room nearby, the Orion will produce a small vial, which he claims contains a small amount of the true Essence. He will offer to let the characters smell it, as proof that it is the genuine substance. He will insist the door of the tiny room be locked and bolted, and the lights be lowered, before he will open the vial. Then, he will gather the group about a small table with a single electrocandle for illumination and open the vial.



The gamemaster should make a secret Saving Roll against the INT score of all characters present, at a penalty of 40 points. (Vulcan characters are not penalized.) No matter what the results, all characters should be told the scent of the Essence fills the room almost immediately, causing all males present to experience a wave of desire. Females present will not be so overwhelmed, but will sense a feeling of contentment and joy.

Characters who make the Saving Roll, however, will shake off the feeling almost immediately, and realize with a start that they have been affected by a hypnotic trance. The Orion is a skilled hypnotist, and has manipulated his words and the atmosphere in the darkened room to enhance the effects of a hypnotic drug in the vial. If anyone comes out of the trance, the Orion will panic and try to run, but can be easily caught. He will not fight if detained by the characters.

The Orion will admit trying to cheat the characters, but will claim he knows nothing of any plot against them (true). In return for his freedom, he will offer to reveal the identity of the person who supplied the hypnotic drug – a local apothecary who the Orion conman believes is tied up with drug smuggling and “with that new bunch at Delfi who have been messing up everything recently.” The weaseling Orion will claim the characters could probably blackmail the apothecary. The apothecary, of course, is Jaclan Uvane.

If no characters make a successful Saving Roll, the hypnotist will cap the vial quickly. Because the effect will last for several minutes, the Orion will probably be able to convince the characters that the vial contains the real Essence. He will ask for 100,000 credits at first, which is beyond the characters’ ability to pay. Eventually, however, he will be able to be bargained down to 10,000 credits or so – cheap if the Essence is genuine.

If the characters leave with the ‘Essence’ and later try it again, they will find it does not work. Analysis will reveal the liquid inside to contain a mild hypnotic drug of some sort in an aromatic form. Returning to the hotel will reveal that the Orion has left, but the hotel clerk will remember getting a big tip from the man when he delivered a small package from the local apothecary. This will, of course, also lead them to the drug dealer Jaclan Uvane.

THE PIT

One of the characters will be approached in some public place by a Human trader who will hand the character a small package.

“Here,” he will say, “but this is the last I can get you. It’s just too hot along the Romulan Neutral Zone. Tell the drug man to get someone else.” The trader will then wait expectantly, hand outstretched.

The character, of course, will have no idea what the trader is talking about. The trader expects to receive a small package in return, containing small gems – contraband which Uvane uses to pay off smugglers who obtain his raw materials. The package given to the player character contains a small amount of a Romulan plant necessary for the manufacture of the hypnotic drug the Uvane supplies to T’Lovus.

Clever talk (requiring a Skill Roll against the character’s rating in *Negotiation/Diplomacy*) may stall the courier for a few moments, but he will eventually insist on his payment. “Well, let’s have it! Uvane owes me on delivery. Where’s my payoff...” he will say, his voice trailing off as he spots another man standing nearby. The second man is wearing a distinctive article of clothing almost identical to one worn by the player character approached. (Gamemasters should use their knowledge of the player character’s habits and dress to elaborate on this situation.) The courier has obviously been sent to meet someone wearing this piece of clothing, and has given the package to the wrong person. The Orion has just discovered this fact.

Unless the player character has specifically stated he is putting the package out of reach (in a pouch, for example), the Orion will realize his error, grab the package and run. The other man will run in the opposite direction. Both are good runners and know the territory. To catch either, a player must *immediately* declare his/her character is attempting to pursue. Then, the player must attempt a Saving Roll against the character's LUC score and another against his CURR OP END score. If three successful series of rolls succeed, the fleeing figure will be caught. Winded, he will be in no shape to fight.

Neither the courier nor the pick-up man will voluntarily reveal anything. If turned over to company police, they will be spirited off and the player characters will learn nothing further. If the characters question either or both men, they will claim to know nothing about the package, even under duress. Allow players with characters who ask questions to attempt a Saving Roll against the character's INT score. A successful roll will allow the character to trick an important response out of a suspect. "I don't know anything about no smelly Romulan weeds!" This response is gained whether the package has been opened in the prisoner's presence or not. The prisoner will then realize he's said too much and quit talking entirely.

At first opportunity, the gamemaster should have the non-player characters captured at this time break away and escape. They are of no further use to the players, as they will not give any other information. This set of clues, however, is enough to link someone named Uvane to smuggling of Romulan plants across the Neutral Zone, which should be enough push to get the characters going. Any local resident can tell them where to find Uvane's apothecary shop.

FINANCIAL QUARTER

As the characters walk down the sidewalk, they will hear a scream and look up just in time to see a falling body. It will strike the ground about a half-block ahead of them. A company policeman nearby will use his communicator to call in backup, then will check the body, cover it with his jacket, and corral passersby (including the characters) as witnesses. In minutes, the place will swarm with police.

The witnesses will be gathered up in a restaurant across the way by two officers, who will make them wait until they can be questioned. A third officer will come in with a crying young woman (a dominant-race orange-skinned Orion) a little while later. The officer will be cool and efficient, and the young woman will react with fury when he asks her to describe what happened.

"You ought to know – you and your blasted company!" The young Orion woman will say angrily to the officer. "I worked for that man for 3 years, him and his little accounting firm. He did good work, and he was the best employer I ever had. Then last week Delfi cancelled all his contracts with the planetary government. They foreclosed on his mortgage, attached his assets – all for no reason! It's happening all over.



Everyone knows it. So this morning he came in, told us all the company was closing up at the end of the week... then went in his office." The woman will stop, brushing tears of fury and sadness out of her eyes. "He... he was standing at the window when I took him his newsfax at noon. I went back a few minutes later to ask if there was anything I could do – and I opened the door and saw him jump..." The woman will then dissolve in tears and be taken away by one officer.

The characters will be questioned briefly about what they saw. When it becomes apparent that the characters know nothing of importance, they will be told that they can leave. The police will not help the characters look for the Orion woman, the office upstairs will be locked and sealed "pending investigation," and within hours it will be as if the incident never happened. Other tenants of the building who knew the dead man will confirm that his small accounting firm once did a lot of work for the Delfi Corporation on a contract basis, and that the man was despondent over his business' collapse when the contracts were cancelled without warning. Other businessmen in the building will tell of contract cancellations by Delfi that are threatening to damage the economic stability of the entire business community. No one will know why such a thing would happen, but all will agree that Delfi corporate leader Kaylo Delfi is running the corporation – and the planet – into the ground.

RESIDENTIAL QUARTER

The characters will be stopped and questioned by three Delfi company policemen about their business in this part of town. No matter what they say, they will be disarmed and taken to the local police station for "questioning." They will be taken before a local sergeant, who will see them in a windowless interrogation room and question them, telling them nothing of value and disbelieving everything they say. After a few preliminary questions, the intercom on the table will buzz, and the sergeant will press a button. A male voice in the other room will ask him to step outside for a moment. Impatiently, he will agree, tapping a button as he exits hurriedly. The characters will be left alone in the room momentarily.

Apparently the last button the sergeant pushed wasn't tapped firmly, because the intercom will still be on. The characters will overhear a conversation (mostly in Galacta) between the unidentified male voice and the sergeant.

VOICE: "We have to cut them loose.

SERGEANT: "Who – these losers? We're supposed to roust anyone halfway suspicious. Who says we have to –"

VOICE (interrupting): "Don't ask me, Sarge! The orders come from Mr. Delfi's office, through his personal guard. Says cut them loose, but keep an eye on them."

SERGEANT (speaking in Orion language – give translation only if a character has a Skill Rating of at least 10): Blasted pointed-ear interloper! Curse that interfering alien, anyway!" (Shifting back to Galacta) "I suppose we have to take orders, but in the old days we'd have told the private guard to eat his own liver..."

VOICE (chuckling): "In the old days, the Boss wasn't as crazy as he is now..."

SERGEANT: "Yes, and that kind of talk will get us both assigned foot patrol in the Pit!"

The characters will then hear the door being opened again. The sergeant will not immediately return to his desk, but will simply stick his head in and tell the player characters to get out and forget the whole thing.

MERCHANT'S QUARTER

A street vendor will be selling a small ornithopter – an inexpensive toy bird made of plastic that flies by flapping its wings when wound up with a tiny crank at its tail. The characters' attention should be attracted to the display, perhaps by allowing a demonstration flight to go awry, ending with the little toy smacking a player character in the nose. The street vendor, an Orion man of advanced years, will apologize profusely and offer to give one of the toys to the offended player character if the character seems like he is angry or liable to cause trouble.



Ask all players whose characters who get a look at the little toy to attempt a Saving Roll against their characters' INT scores. Give a 20- point bonus on the roll to anyone who has been involved in combat with a Romulan *Bird Of Prey* class ship during the campaign, has specialized Romulan knowledge (with a skill rating of 10 or over), or examines the toy very closely. Those who succeed will recognize the colorful wing pattern on the bird as being quite similar to that of the stylized bird symbol used to decorate many Romulan warships.

The old peddler will know nothing of the designs on the wings, stating he simply buys the toys from a supplier – a Delfi corporation subsidiary that manufactures them locally. He will mention that they are a relatively new item, and sell quite well.

If the characters pursue the matter, they will be directed to a small warehouse outlet in the merchant's quarter. The Orion who runs the place will be friendly enough, telling them he is happy to have such a good selling product, with the local economy so depressed. He will reveal that he designed the toy himself years ago, based on an Orion bird-form, but that the toy never sold well until the new, more

colorful pattern was added recently. He will tell the characters that the new design he copied from a sketch he picked up from the floor in a family board meeting a short while back. He will say he still has it, and will be glad to show it to the players. They will find it to be a doodle, done with a common multicolor stylus on ordinary paper, of an old-style Romulan *Bird Of Prey* class ship in flight. The Orion will tell them he has a vague recollection that the guard who dropped the sketch "might have been a Vulcan," but he will not be sure.

RANDOM ENCOUNTERS

Whenever the players travel afoot in Bonus Run Center, there is a chance for an encounter, as detailed in the sections describing Bonus Run Center. The tables give the frequency of encounter rolls for time elapsed and distance travelled. They also give the encounter types, which are described below. The gamemaster should feel free to add to the Random Encounter Tables or alter them to suit the type of game action desired. Furthermore, he should feel free to elaborate on any of the encounters described below, or ignore a rolled encounter entirely if it does not fit in with his plans. The responsibility for running an interesting, fair game belongs to *him*, not his dice.

It is recommended that the gamemaster make the encounter rolls in secret. This will allow him to give appropriate commentary (such as "hmmmmm, that's interesting") for pre-planned encounters, random encounters, and even when no encounter is forthcoming. This will keep player characters guessing about the significance of any encounter to the plot-line.

NO ENCOUNTER

With this roll, there will be no encounter of significance. If he desires, the gamemaster may make up a harmless, nuisance encounter.

PICKPOCKET ATTEMPT

A cutpurse will attempt to pickpocket one of the player characters, selected randomly. This attempt may be successful or not, depending on the player character's Skill Rating in *Streetwise* and the pickpocket's luck. Furthermore, the player character may be lucky enough to catch the pickpocket, or unlucky enough to lose everything. This encounter will happen only once in an area, with Pickpocket Attempt rolls thereafter being treated as No Encounter rolls.

Determining Pickpocket's Success

To see if the attempt was successful, have the player roll percentile dice, the lower the better. This roll is not a Skill Roll, and so it is not made against the character's rating in any skill. Instead, the roll is increased by 40 (the pickpocket's skill) minus the character's rating in *Streetwise*. Then, the modified dice roll is compared to the table below to determine the result of the attempt.

For example, a pickpocket attempts to steal a player character's wallet. The player makes a dice roll of 54, and his character has a rating in *Streetwise* of 25. This makes the roll a 69 ($40 - \text{the character's Skill Rating of } 25 = 15; \text{ the dice roll of } 54 + 15 = 69$). Comparing with the table shows that the pickpocket was successful, and now has the player character's wallet.

If, instead, the player character's Skill Rating had been 63, the modified roll would have been 31 ($40 - 63 = -23; 54 - 23 = 31$), and the pickpocket's attempt would have failed.

Pickpocket Results Table

Dice Roll	Results
01 - 25	Critical Failure.
26 - 50	Attempt Failed.
51 - 60	Attempt Aborted: Feint Only
61 - 95	Attempt Successful.
96 - 00	Critical Success.

Modifier To Roll = 40 - *Streetwise* Rating

Results Explanations

The following paragraphs explain what occurs in the pickpocket attempt. Because they depend on the particular situation, it is up to the gamemaster to take these results and turn them into exciting role play.

Critical Failure: For this result, the lower the modified roll, the worse for the thief. The thief may be apprehended automatically. Perhaps, clumsy oaf that he is, he caught his hand in his mark's pocket and was unable to remove it before the player character turned around and grabbed him. Unarmed personal combat is a likely result. It might be that the thief tripped on the proverbial banana peel just after he grabbed the wallet, falling to the ground before the player character, wallet in hand and look of horror on his face. Perhaps the player character tripped, grabbing onto the thief for support, and just happened to grab the thief's wallet before the thief took off like a shot.

Attempt Failed: The thief made the attempt, failed, and moved away. The attempt may be noticed, as described below.

Feint Only: The thief moved in for the attempt, saw that the mark was not as easy as he first appeared to be, and aborted the attempt. The aborted attempt may be noticed, as described below.

Attempt Successful: The thief successfully grabbed the character's wallet (including his ID card) and moved away. There is a chance that the character may have noticed the attempt, as described below.

Critical Success: The thief's success was so great that the character lost the gold fillings out of his back teeth. He was picked clean of wallet, tricorder, phaser, communicator, and any other gear, and he did not notice a thing.

Noticing The Attempt

To determine if the mark (a player character) notices the pickpocket's attempt, make a Saving Roll against the character's LUC score minus 40. If the roll is unsuccessful, the character will not notice the attempt. If, however, the roll is successful, the player character will notice the attempt and may give chase.

Apprehending The Thief

If the player character gives chase, the player must make a Saving Roll against his character's CURR OP END score to avoid being winded and giving up the chase in the middle as well as 3 successful Saving Rolls against his character's DEX score to catch the thief. If caught, the thief will surrender without a fight and can be turned over to company security. If pressured, he will give what he has (1D100 credits in Orion currency) if the characters will let him go.

Replacing Stolen Goods

It will take a day to replace a stolen ID. A weapon may be purchased only after the player character has had his new ID cleared, unless it is purchased on the black market at 1.5 times its normal value.

LEGITIMATE STREET DEALER

The player characters will be approached by a legitimate street salesman, offering "ground clothes" (50-credit suits of clothing being pawned off as local fashion, but which actually is quite out-of-style), or "city maps" (at 20 credits - vastly overpriced). If anyone is really interested, the dealer can be worked down to 25% of the original price with successful dickering (that is, successful Skill Rolls against the character's rating in *Negotiation/Diplomacy* or *Trade And Commerce*. Gamemasters are encouraged to come up with their own overpriced and basically useless items to offer to the "dumb outworlders." This encounter can occur any number of times.

ILLEGAL OFFER

Bogus Offer And Mugging

The player characters are approached with an offer of drugs, female companionship with a green Orion woman, or something else illegal. The offer is phony, and accepting it will cue the salesman to lead the characters into a back alley. There, the player character will be jumped by 1D10 Orion toughs armed with knives and Klingon disruptors (50% chance for each weapon).

If the player characters fight successfully, they will be able to confiscate weapons and get 1D100 credits per tough before the company police arrive to take the toughs away. If the characters look like they are losing, they will be rescued by city guards the first time, with no losses.

If the player characters fall for this a second time and lose, they will be robbed but left alive, if possible. Any stolen goods must be replaced as described above.

Legitimate Offer

This illegal offer is identical to that described above, except that it will be legitimate, with the goods/services actually available, but costing about 1.5 times what they are normally worth.

BLACK MARKET BROKER

The player characters will be approached by a black market broker. See the rules for dealing with such brokers in **The Shadow Market** section.

BUREAUCRATIC HASSLE

The player characters will have a minor bureaucratic hassle over ship berthing, ID, or something similar. This will delay them for one hour unless they offer a bribe of at least 10 credits. A successful Skill Roll against the offering player character's rating in *Bribery* will reduce the bribe necessary to 5 credits.

DELFI COMPANY GUARDS

The player characters will be stopped and questioned about their business by Delfi company guards.

Financial Quarter

In the Financial Quarter, they will be delayed for one hour if their spokesman is unsuccessful at handling the situation. The player should make a Skill Roll against his character's rating in *Negotiation/Diplomacy*; if the roll is successful, there will be no delay. A bribe of 20 credits or more also will cut the red tape.

Residential Quarter

In the Residential Quarter, unless the player characters have a good reason to be here, they will be asked to leave. One player must make a successful Skill Roll against his character's rating in *Negotiation/Diplomacy* for the group to be allowed to stay. If asked to leave, the player characters may try a bribe. One player should make a Skill Roll against his character's rating in *Bribery* when the bribe is offered. If the bribe is not 40 credits or more, or if the Skill Roll is unsuccessful, the player characters will be run out of the area immediately.

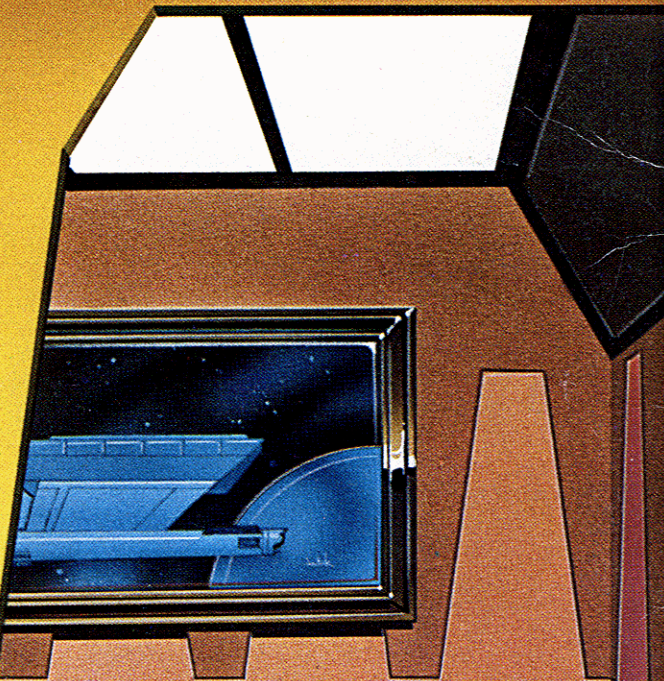
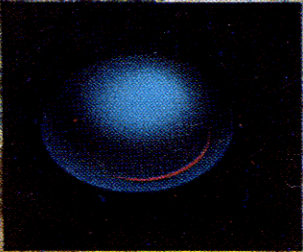

Greetings, old comrade!

I trust that this message finds you well and that your career is going smoothly. It has been a long time since we were in contact, and so it is difficult for me to presume by asking for a favor. What I ask I cannot explain, but much depends on this.

You will be contacted by a Vulcan named Satak, who is on a mission of utmost secrecy dealing with a renegade Romulan. I urge you and a few of your best fellow officers to aid him with his mission, though you will have no official Star Fleet sanction.

Do not attempt to contact me. I cannot respond, and would be forced to deny all.

For whatever it is worth, I wish you the luck that Humans seem to put so much faith in.

Sonam